



Standard Practice for Guarded-Hot-Plate Design Using Circular Line-Heat Sources¹

This standard is issued under the fixed designation C 1043; the number immediately following the designation indicates the year of original adoption or, in the case of revision, the year of last revision. A number in parentheses indicates the year of last reapproval. A superscript epsilon (ϵ) indicates an editorial change since the last revision or reapproval.

1. Scope

1.1 This practice covers the design of a circular line-heat-source guarded hot plate for use in accordance with Test Method C 177.

NOTE 1—Test Method C 177 describes the guarded-hot-plate apparatus and the application of such equipment for determining thermal transmission properties of flat-slab specimens. In principle, the test method includes apparatus designed with guarded hot plates having either distributed- or line-heat sources.

1.2 The guarded hot plate with circular line-heat sources is a design in which the meter and guard plates are circular plates having a relatively small number of heaters, each embedded along a circular path at a fixed radius. In operation, the heat from each line-heat source flows radially into the plate and is transmitted axially through the test specimens.

1.3 The meter and guard plates are fabricated from a continuous piece of thermally conductive material. The plates are made sufficiently thick that, for typical specimen thermal conductances, the radial and axial temperature variations in the guarded hot plate are quite small. By proper location of the line-heat source(s), the temperature at the edge of the meter plate can be made equal to the mean temperature of the meter plate, thus facilitating temperature measurements and thermal guarding.

1.4 The line-heat-source guarded hot plate has been used successfully over a mean temperature range from -10 to $+65^\circ\text{C}$, with circular metal plates and a single line-heat source in the meter plate. The chronological development of the design of circular line-heat-source guarded hot plates is given in Refs (1-9).²

1.5 This practice does not preclude (1) lower or higher temperatures; (2) plate geometries other than circular; (3) line-heat-source geometries other than circular; (4) the use of plates fabricated from ceramics, composites, or other materials; or (5) the use of multiple line-heat sources in both the meter and guard plates.

1.6 This standard does not purport to address all of the safety concerns, if any, associated with its use. It is the responsibility of the user of this standard to establish appropriate safety and health practices and determine the applicability of regulatory limitations prior to use.

2. Referenced Documents

2.1 ASTM Standards:³

C 168 Terminology Relating to Thermal Insulation

C 177 Test Method for Steady-State Heat Flux Measurements and Thermal Transmission Properties by Means of the Guarded-Hot-Plate Apparatus

C 1044 Practice for Using a Guarded-Hot-Plate Apparatus or Thin-Heater Apparatus in the Single-Sided Mode

E 230 Specification and Temperature-Electromotive Force (EMF) Tables for Standardized Thermocouples

2.2 ASTM Adjuncts:

Line-Heat-Source Guarded-Hot-Plate Apparatus⁴

3. Terminology

3.1 *Definitions*—For definitions of terms and symbols used in this practice, refer to Terminology C 168. For definitions of terms relating to the guarded-hot-plate apparatus refer to Test Method C 177.

3.2 *Definitions of Terms Specific to This Standard:*

3.2.1 *gap, n*—a separation between the meter plate and guard plate, usually filled with a gas or thermal insulation.

3.2.2 *guard plate, n*—the outer ring of the guarded hot plate that encompasses the meter plate and promotes one-dimensional heat flow normal to the meter plate.

3.2.3 *guarded hot plate, n*—an assembly, consisting of a meter plate and a co-planar, concentric guard plate, that provides the heat input to the specimens.

3.2.4 *line-heat-source, n*—a thin or fine electrical heating element that provides uniform heat generation per unit length.

3.2.5 *meter area, n*—the mathematical area through which the heat input to the meter plate flows normally under ideal guarding conditions into the meter section of the specimen.

¹ This practice is under the jurisdiction of ASTM Committee C16 on Thermal Insulation and is the direct responsibility of Subcommittee C16.30 on Thermal Measurement.

Current edition approved Sept. 1, 2006. Published October 2006. Originally approved 1985. Last previous edition approved in 2002 as C 1043 – 97(2002).

² The boldface numbers in parentheses refer to a list of references at the end of this practice.

³ For referenced ASTM standards, visit the ASTM website, www.astm.org, or contact ASTM Customer Service at service@astm.org. For *Annual Book of ASTM Standards* volume information, refer to the standard's Document Summary page on the ASTM website.

⁴ Available from ASTM Headquarters. Order Adjunct: ADJC1043.

3.2.6 *meter plate, n*—the inner disk of the guarded hot plate that contains one or more line-heat sources embedded in a circular profile and provides the heat input to the meter section of the specimens.

3.2.7 *meter section, n*—the portion of the test specimen (or auxiliary insulation) through which the heat input to the meter plate flows under ideal guarding conditions.

4. Significance and Use

4.1 This practice describes the design of a guarded hot plate with circular line-heat sources and provides guidance in determining the mean temperature of the meter plate. It provides information and calculation procedures for: (1) control of edge heat loss or gain (Annex A1); (2) location and installation of line-heat sources (Annex A2); (3) design of the gap between the meter and guard plates (Appendix X1); and (4) location of heater leads for the meter plate (Appendix X2).

4.2 A circular guarded hot plate with one or more line-heat sources is amenable to mathematical analysis so that the mean surface temperature can be calculated from the measured power input and the measured temperature(s) at one or more known locations. Further, a circular plate geometry simplifies the mathematical analysis of errors resulting from heat gains or losses at the edges of the specimens (see Refs (10, 11)).

4.3 In practice, it is customary to place the line-heat source(s) in the meter plate at a prescribed radius such that the temperature at the outer edge of the meter plate is equal to the mean surface temperature over the meter area. Thus, the determination of the mean temperature of the meter plate can be accomplished with a small number of temperature sensors placed near the gap.

4.4 A guarded hot plate with one or more line-heat sources will have a radial temperature variation, with the maximum temperature differences being quite small compared to the average temperature drop across the specimens. Provided guarding is adequate, only the mean surface temperature of the meter plate enters into calculations of thermal transmission properties.

4.5 Care must be taken to design a circular line-heat-source guarded hot plate so that the electric-current leads to each heater either do not significantly alter the temperature distributions in the meter and guard plates or else affect these temperature distributions in a known way so that appropriate corrections can be made.

4.6 The use of one or a few circular line-heat sources in a guarded hot plate simplifies construction and repair. For room-temperature operation, the plates are typically of one-piece metal construction and thus are easily fabricated to the required thickness and flatness. The design of the gap is also simplified, relative to gap designs for distributed-heat-source hot plates.

4.7 In the single-sided mode of operation (see Practice C 1044), the symmetry of the line-heat-source design in the axial direction minimizes errors due to undesired heat flow across the gap.

5. Design of a Guarded Hot Plate with Circular Line-Heat Source(s)

5.1 *General*—The general features of a circular guarded-hot-plate apparatus with line-heat sources are illustrated in Fig. 1. For the double-sided mode of operation, there are two specimens, two cold plates, and a guarded hot plate with a gap between the meter and guard plates. The meter and guard plates are each provided with one (or a few) circular line-heat sources.

5.2 *Summary*—To design the meter and guard plates, use the following suggested procedure: (1) establish the specifications and priorities for the design criteria; (2) select an appropriate material for the plates; (3) determine the dimensions of the plates; (4) determine the type, number, and location of the line-heat source(s); (5) design the support system for the plates; and (6) determine the type, number, and location of the temperature sensors.

5.3 *Design Criteria*—Establish specifications for the following parameters of the guarded hot-plate apparatus: (1) specimen diameter; (2) range of specimen thicknesses; (3)

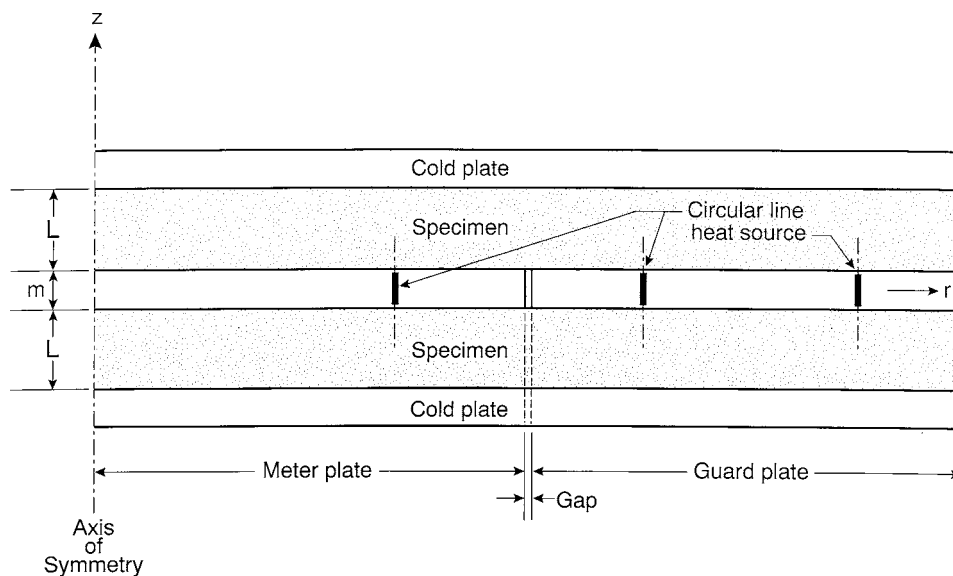

FIG. 1 Schematic of a Line-Heat-Source Guarded-Hot-Plate Apparatus

range of specimen thermal conductances; (4) characteristics of specimen materials (for example, stiffness, mechanical compliance, density, hardness); (5) range of hot-side and cold-side test temperatures; (6) orientation of apparatus (vertical or horizontal heat flow); and (7) required measurement precision.

NOTE 2—The priority assigned to the design parameters depends on the application. For example, an apparatus for high-temperature may necessitate a different precision specification than that for a room-temperature apparatus. Examples of room-temperature apparatus are available in the adjunct.⁴

5.4 *Material*—Select the material for the guarded hot plate by considering the following criteria:

5.4.1 *Ease of Fabrication*—Fabricate the guarded hot plate from a material that has suitable thermal and mechanical properties and which can be readily fabricated to the desired shapes and tolerances, as well as facilitate assembly.

5.4.2 *Thermal Stability*—For the intended range of temperature, select a material for the guarded hot plate that is dimensionally stable, resistant to oxidation, and capable of supporting its own weight, the test specimens, and accommodating the applied clamping forces without significant distortion. The coefficient of thermal expansion must be known in order to calculate the meter area at different temperatures.

5.4.3 *Thermal Conductivity*—To reduce the (small) radial temperature variations across the guarded hot plate, select a material having a high thermal conductivity. For cryogenic or modest temperatures, it is recommended that a metal such as copper, aluminum, silver, gold or nickel be selected. For high-temperature (up to 600 or 700°C) use in air, nickel or a single-compound ceramic, such as aluminum oxide, aluminum nitride, or cubic boron nitride is recommended.

5.4.4 *Heat Capacity*—To achieve thermal equilibrium quickly, select a material having a low volumetric heat capacity (product of density and specific heat). Although aluminum, silver, and gold, for example, have volumetric heat capacities lower than copper, as a practical matter, either copper or aluminum is satisfactory.

NOTE 3—Heat capacity is particularly important when acquiring test data by decreasing the mean temperature. Since the meter plate, for most designs, can only lose heat through the test specimens, the meter plate may cool quite slowly.

5.4.5 *Thermal Emittance*—To achieve a uniform, high thermal emittance, select a plate material that will accept a suitable surface treatment. The treatment should also provide good oxidation resistance. For modest temperatures, various high emittance paints can be used for copper, silver, gold, or nickel. For aluminum, a black anodized treatment provides a uniformly high emittance. For high-temperature, most ceramics have an inherently high thermal emittance and nickel and its alloys can be given a fairly stable oxide coating. In any case, the thermal emittance should not change significantly with aging.

5.5 *Guarded-Hot-Plate Dimensions*—Select the geometrical dimensions of the guarded hot plate to provide an accurate determination of the thermal transmission properties.

NOTE 4—The accurate determination of thermal transmission properties requires that the heat input to the meter plate flows normally through the specimens to the cold plates. One-dimensional heat flow is attained by

proper selection of the diameter of the meter plate relative to the diameter of the guard plate while also considering (1) the specimen thermal conductivities; (2) specimen thicknesses; (3) edge insulation; and, (4) secondary guarding, if any.

5.5.1 *Meter Plate Diameter*—The diameter shall be large enough so that the meter section of the specimens is statistically representative of the material. Conversely, the diameter needs to be sufficiently smaller than the diameter of the guard plate so that adequate guarding from edge heat losses can be achieved (see 5.5.2).

NOTE 5—The first requirement is particularly critical for low-density insulations that may be inhomogeneous. The second requirement is necessary in order to provide adequate guarding for the testing of the specimen materials and thicknesses of concern.

5.5.2 *Guard Plate Diameter*—Use Annex A1 to determine either the diameter of the guard plate for a given meter plate diameter, or the diameter of the meter plate for a given guard plate diameter. Specifically, determine the combinations of diameters of the meter plate and guard plate that will be required so that the edge-heat-loss error will not be excessive for the thickest specimens, with the highest lateral thermal conductances. If necessary, calculate the edge heat loss for different edge insulation and secondary-guarding conditions.

NOTE 6—For example, when testing relatively thin specimens of insulation, it may be sufficient to maintain the ambient temperature at essentially the mean temperature of the specimens and to use minimal edge insulation without secondary guarding. However, for thicker conductive specimens, edge insulation and stringent secondary guarding may be necessary to achieve the desired test accuracy.

5.5.3 *Guarded-Hot-Plate Thickness*—The thickness should be large enough to provide proper structural rigidity, and have a large lateral thermal conductance, thus minimizing radial temperature variations in the plate. Conversely, a large thickness will increase the heat capacitance of the plate and thus adversely affect the (rapid) achievement of thermal equilibrium, and reduce the thermal isolation between the meter plate and the guard plate.

5.5.4 *Gap Width*—The gap shall have a uniform width such that the gap area, in the plane of the surface of the guarded hot plate, shall be less than 3 % of the meter area. In any case, the width of the gap shall not exceed the limitations given in Test Method C 177. The width of the gap is a compromise between increasing the separation in order to reduce lateral heat flow and distorting the heat flow into the specimen and increasing the uncertainty in the determination of the meter area.

NOTE 7—The gap provides a significant thermal resistance between the meter and guard plates. The temperature difference across the gap needs to be maintained at a very small value, thereby minimizing the heat transfer between the meter and guard plates, both directly across the gap and also through adjacent portions of the specimens.

5.5.5 *Gap Configuration*—Refer to Fig. 2 in selecting an appropriate design for the gap cross-section. Designs (b) and (c) permit a narrow gap at the surfaces, in the plane of the plate, while maintaining a fairly high thermal resistance between the meter and guard plates. For a small temperature difference across the gap, calculate the corresponding heat flow using guidelines in Appendix X1.

5.5.6 *Plate Flatness*:

Gap Configurations

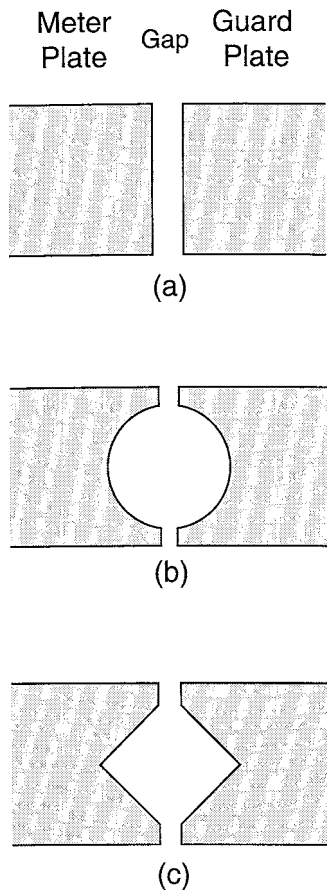

FIG. 2 Designs for the Cross-section of the Gap Between the Meter and Guard Plates

5.5.6.1 When assembled, the guarded hot plate shall have the surfaces of both the meter and guard plates flat to within 0.025 % of the outer diameter of the guard plate.

NOTE 8—For example, a guarded hot plate with a 600-mm diameter guard plate should be flat over its entire surface to within 0.15 mm.

5.5.6.2 During fabrication, assembly, and installation of the guarded hot plate, considerable care needs to be taken to achieve this flatness tolerance. For a metal plate, it may be necessary to anneal the plate to relieve stresses introduced during machining and then grind the plate(s) to final tolerances. Continued checking may be necessary to ensure the flatness tolerance is maintained after temperature cycling.

5.5.7 Surface Emittances:

5.5.7.1 *Guarded Hot Plate*—Treat the surfaces of the guarded hot plate to maintain a total hemispherical emittance greater than 0.8. In any case, the hot plate surface emittance shall meet the requirements of Test Method C 177.

5.5.7.2 *Gap*—To minimize the heat flow across the gap, either treat the surfaces of the gap (by polishing or electroplating) to reduce their thermal emittance, or fill the gap with thermal insulation.

5.6 *Heater Design*—Select the radius of each circular line-heat source for the meter plate and the guard plate as follows.

5.6.1 Location of Heaters:

5.6.1.1 *Meter Plate*—If the meter plate has a single line-heat source, locate the heat source at a radius equal to $\sqrt{2}/2$ times the radius to the center of the gap. If it is desired to have heaters at more than one radius, select these radii by using the criteria given in Annex A2.

5.6.1.2 *Guard Plate*—For a guarded hot plate with the outer radius of the guard plate equal to 2.5 times the radius to the center of the gap, locate the line-heat source at a radius equal to 1.29 times the radius to the center of the gap. If another line-heat source is required in the guard plate, locate the heat source at a radius of 1.97 times the radius to the center of the gap. Use the criteria given in Annex A2 for determining other radii of line-heat sources in the guard plate.

NOTE 9—The location(s) of the line-heat sources in the guard plate is less critical than is the case for the meter plate.

5.6.2 *Type of Heater*—Select the line-heat source from one of the following types of heater elements: (1) thin ribbon; (2) sheathed; or (3) any other stable type that provides a uniform heat output per unit length, for example, fine resistance wire with dielectric insulation.

5.6.2.1 *Ribbon Heater*—A thin ribbon heater consists of an etched foil or wire-wound heating element sandwiched between two layers of electrical insulation. For a guarded hot plate intended for use over the temperature range of building insulations, the electrical insulation can be any of a variety of plastics (for example, polyimide). For use over a broader temperature range, care must be taken to select an insulation, such as high-temperature polyimide or silicone rubber, that will survive the temperatures of interest.

5.6.2.2 *Sheathed Heater*—A sheathed heater, sometimes known as a cable heater or a swaged heater, consists of a straight or coiled heater element insulated from its surrounding metal sheath by compacted ceramic powder. This type of heater can be used to quite high temperatures, depending upon the type of resistance wire and sheath that are selected.

5.6.3 Installation of Heaters:

5.6.3.1 Install the ribbon heater(s) by fabricating the plate (meter or guard) in two concentric sections and placing the heater between the sections by either an interference fit or a tapered fit. Prepare the interference fit by applying a moderate temperature difference to the two concentric sections. See adjunct for further details.⁴

5.6.3.2 Install the sheathed heater(s) by pressing the heater into circular grooves that have been cut into one (or more) surface(s) of the plate (meter or guard). The grooves should be deep enough that the heater will be below the surface of the plate. Fill the remainder of the groove with either conductive epoxy, solder, or braze.

5.6.4 *Lead Wires for Heater*—In order to minimize undesired heat generation from the heater leads, select lead wires that have a lower electrical resistance per unit length than the heater element(s). The heater elements may have either integral electrical lead wires, or individual insulated lead wires attached to the heater elements with the junctions electrically insulated (with, for example, epoxy or ceramic cement). Secure the electrical connections so they are reliable and properly insulated electrically from the guarded hot plate.

NOTE 10—Since some heat will be generated by the wire leads, thereby perturbing the temperature profile, consideration must be given to where the leads are located and how they are installed. Refer to [Appendix X2](#) for guidance on locating the wire heater leads.

5.7 Support Structures:

5.7.1 *Support for Meter Plate*—Design the support system for the meter plate to:

5.7.1.1 Facilitate assembly of the meter and guard plates so that the two plates are co-planar (per [5.5.6](#)) and concentric with a uniform gap width (per [5.5.4](#)),

5.7.1.2 Support the mass of the meter plate as well as the forces from clamping the test specimens,

5.7.1.3 Account for the effects of thermal expansion of the meter and guard plates,

5.7.1.4 Minimize heat conduction between the meter and guard plates, and

5.7.1.5 Facilitate installation and repair of the line-heat sources, lead wires, and sensors.

NOTE 11—Extraneous heat flows caused by the support system could disturb the desired temperature distribution in the meter plate. One successful technique consists of a system of three small pins with both ends tapered that are installed in radially drilled holes in the guard plate. A tapered-end screw pushed against the outer end of each pin presses the other end of the pin into a circumferential groove in the outer edge of the meter plate. This system will center the meter plate accurately so that the gap width is uniform (per [5.5.4](#)).

5.7.2 *Support for Guard Plate*—Design the support system for the guard plate to maintain the guarded hot plate in the desired orientation (usually the plane of the hot plate will be either horizontal or vertical), and, minimize conductive heat losses from the guard plate.

NOTE 12—Extraneous heat flows caused by the support structure could disturb the desired temperature distribution in the guard plate. One successful technique for supporting the guard plate is wire cables (at three or four locations) at the periphery of the guard plate. A second technique is to rigidly support the underside of the guard plate at the periphery either from above or below.

5.8 Temperature Sensors:

5.8.1 *Type*—Select temperature sensors for the guarded hot plate that provide adequate sensitivity and do not significantly change the temperatures that are to be measured. At modest temperatures, select sensors from the following types: (1) thermocouples (either Type T or E wire being the most commonly used); (2) small, accurate (platinum) resistance thermometers; or (3) stable thermistors. At extreme temperatures (high or cryogenic), consult Specification [E 230](#) or Ref [\(12\)](#) for the use of thermocouples for temperature measurement.

5.8.2 *Calibration*—Temperature sensors shall be calibrated with standards traceable to a national standards laboratory.

NOTE 13—The overall uncertainty depends not only on the type of sensor and its calibration, but also on the measurement system. Normal precautions require minimizing spurious voltages by locating junctions of dissimilar metals in regions of low thermal gradients and using high quality low-thermal emf switches. For further guidelines, consult Test Method [C 177](#).

5.8.3 *Location in Meter Plate*—If the line-heat source(s) is located per [5.6.1](#) in the meter plate, then locate the temperature sensor at the outer radius of the meter plate. Consult [Appendix](#)

[X2](#) for the angular location of the temperature sensor. Locate the temperature sensor at the center plane of the meter plate.

5.8.4 *Location in Gap*—Use a thermopile to detect directly the temperature difference across the gap, rather than separate measurements of the absolute temperature of the meter and guard-sides. In order to minimize heat conduction through the thermopile wires, select (1) wires of small diameter and low thermal conductivity; (2) the minimum number of thermocouple junction pairs necessary for adequate sensitivity; and (3) an oblique (rather than radial) path for the wires to cross the gap.

5.8.4.1 *Type of Wire*—In general, avoid constructing the thermopile from copper wires. Because of its high sensitivity and relatively low thermal conductivity of both alloys, consider Type E thermocouple wire, having a diameter no greater than 0.3 mm.

5.8.4.2 *Sensitivity*—For a line-heat-source guarded hot plate, angular temperature variations on either side of the gap should be small so that only a small number of thermocouple junctions for sampling purposes is required, provided the junctions are wisely located relative to the heater leads (see [Appendix X2](#)).

NOTE 14—Different designs for guarded hot plates have used anywhere from a few pairs of thermocouple junctions to several hundred pairs to achieve both adequate sensitivity and adequate sampling of the temperature on either side of the gap. The number of thermocouple junctions needs to provide the desired resolution of the temperature difference across the gap. For example, if thermocouple wire with a nominal sensitivity of 60 $\mu\text{V/K}$ were used, a thermopile with 16 pairs of junctions would have a sensitivity of 960 $\mu\text{V/K}$. For such a thermopile, measurement of the thermopile output to a resolution of 1 μV would correspond to a resolution in the temperature difference across the gap of approximately 1 mK.

5.8.4.3 *Installation*—Place all thermocouple junctions in good thermal contact with the meter plate or guard plate. Secure, if necessary, by mechanical fasteners. Insulate electrically all thermocouple junctions from the meter plate and guard plate.

5.8.5 *Location in Guard Plate*—Measure the temperatures of the primary guard using thermocouples, (platinum) resistance thermometers, or thermistors, or indirectly using differential thermocouples.

NOTE 15—Temperatures in the guard plate do not enter directly into the calculation of thermal transmission properties. However, it is important to measure temperatures at some locations in the guard plate so that correct operation of the guarded hot plate can be verified.

6. Design Precautions

6.1 Error in the measurement of the temperature of the guarded hot plate can be introduced from several sources, including: (1) improper design of the guarded hot plate; (2) location of the temperature sensor; and (3) calibration of the temperature sensor as well as the measurement system (see [5.8.2](#)).

6.2 A basic premise in the design of the guarded hot plate is the location of the line-heat source at a prescribed radius as described in [Annex A2](#). This ensures that the mean temperature of the surface of the meter plate is equal to the temperature at the edge of the meter plate. The radial temperature profile is

affected by the thermal conductivity of the plate. Consequently, the thermal conductivity of the plate should be high relative to the specimen (see Annex A2).

6.3 Experimental checks to verify the radial temperature distribution are recommended. These include independent temperature measurements of the guarded hot plate with thermocouples, for example, as described in Refs (5), (8).

6.4 Angular perturbations in the temperature profile are possible due to heating from the heater leads crossing the gap.

Additional temperature sensors may be necessary to determine adequately the mean temperature of the surface of the meter plate.

7. Keywords

7.1 guarded hot plate apparatus; heat flow; line source heater; steady state; thermal conductivity; thermal insulation; thermal resistance

ANNEXES

(Mandatory Information)

A1. CONTROL OF EDGE HEAT LOSS OR GAIN

A1.1 Scope

A1.1.1 This annex provides a procedure for determining the diameter of the guard plate and ambient temperature conditions required to reduce the edge effects to negligible proportions. Alternative procedures may be used, but it is the responsibility of the user to determine that those procedures yield equivalent results.

A1.2 Theoretical Analysis

A1.2.1 For an apparatus with an isothermal guarded hot plate and cold plate(s), the error due to edge heat loss or gain has been derived for both circular and square plates by Peavy and Rennex (10), for the case of the specimen being anisotropic, and by Bode (11), for the isotropic case. The error due to edge heat transfer in a guarded hot plate apparatus is given by:

$$\epsilon = A + BX \quad (\text{A1.1})$$

where:

$$X = \frac{2(T_m - T_a)}{T_h - T_c} \quad (\text{A1.2})$$

Here, T_h is the guarded hot plate temperature, and T_c , the cold plate temperature. The mean temperature of the specimen is $T_m = (T_h + T_c)/2$, and T_a is the ambient temperature at the edge of the specimen.

A1.2.2 For a circular plate geometry, the coefficients A and B are given by:

$$A = \sum_{n=1}^{\infty} W_{2n} \quad (\text{A1.3})$$

$$B = \sum_{n=1}^{\infty} W_{2n-1} \quad (\text{A1.4})$$

The terms in the summations are given by:

$$W_n = \frac{4}{\pi^2} \left(\frac{hL}{\lambda} \right) \left(\frac{\gamma L}{b} \right) \frac{I_1(n\pi b/\gamma L)}{n^2 [I_1(n\pi d/\gamma L) + (hL/n\pi\lambda)I_0(n\pi d/\gamma L)]} \quad (\text{A1.5})$$

where I_0 and I_1 are modified Bessel functions of the first kind of order 0 and 1, respectively, b is the radius to the center of the gap, d is the outer radius of the guard plate, L is the thickness of the specimen, and h is the heat transfer coefficient at the

circumference of the specimen. The anisotropy ratio for the specimen is $\gamma^2 = \lambda_r/\lambda_z$ where λ_r and λ_z are the thermal conductivities in the radial and axial directions, respectively. The geometrical mean of the thermal conductivities is $\lambda = (\lambda_r\lambda_z)^{1/2}$.

A1.2.3 For the range of parameters that provide appropriate guarding, Eq A1.3 and Eq A1.4 are convergent and require only a few terms to obtain accurate results. Peavy and Rennex (10) provide plots of A and B as functions of geometry and of the ratio of heat transfer coefficient, h , to specimen conductivity.

A1.2.4 For relatively small values of A and B , approximate universal curves can be obtained by writing:

$$A = \frac{\frac{hL}{\lambda}}{1 + \left(1 + \frac{\gamma L}{4\pi d}\right) \frac{hL}{2\pi\lambda}} A' \quad (\text{A1.6})$$

$$B = \frac{\frac{hL}{\lambda}}{1 + \left(1 + \frac{\gamma L}{2\pi d}\right) \frac{hL}{\pi\lambda}} B' \quad (\text{A1.7})$$

where A and B are computed from Eq A1.3 and Eq A1.4 and A' and B' are then computed using Eq A1.6 and Eq A1.7. Fig. A1.1 and Fig. A1.2 present parametric curves of A' and B' , respectively, as functions of $\gamma L/d$. The values computed for A' and B' are also weak functions of hd/λ . The widths of the lines shown in Fig. A1.1 and Fig. A1.2 correspond to the variations due to hd/λ being varied from 0.1 to infinity. Fig. A1.1 and Fig. A1.2 can be used to obtain values of A' and B' , from which A and B can be computed using Eq A1.6 and Eq A1.7.

A1.2.5 For values of d/b not shown, or for values of $\gamma L/d$ larger than unity, A and B can be obtained from Peavy and Rennex (10) or computed directly from Eq A1.3 and Eq A1.4. Alternatively, upper limits on A' and B' can be computed simply from the expressions:

$$A' < \frac{1}{\pi^2} \left(\frac{\gamma L}{b} \right) \left(\frac{d}{b} \right)^{1/2} \exp \left(\frac{-2\pi(d-b)}{\gamma L} \right) \quad (\text{A1.8})$$

$$B' < \frac{4}{\pi^2} \left(\frac{\gamma L}{b} \right) \left(\frac{d}{b} \right)^{1/2} \exp \left(\frac{-\pi(d-b)}{\gamma L} \right) \quad (\text{A1.9})$$

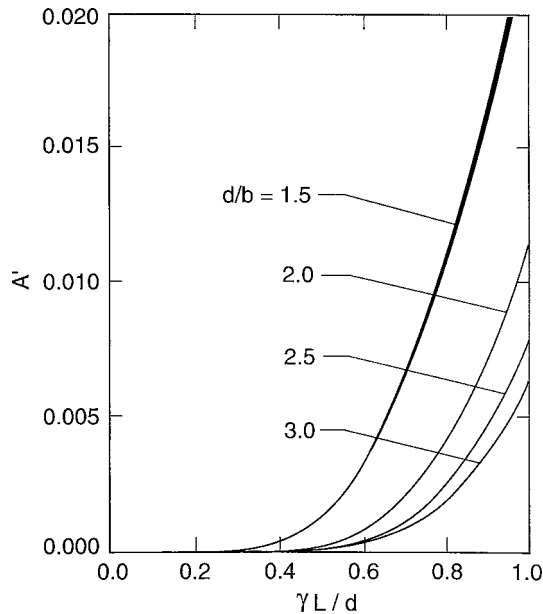

FIG. A1.1 The Coefficient A' as a Function of $\gamma L/d$ with d/b as a Parameter

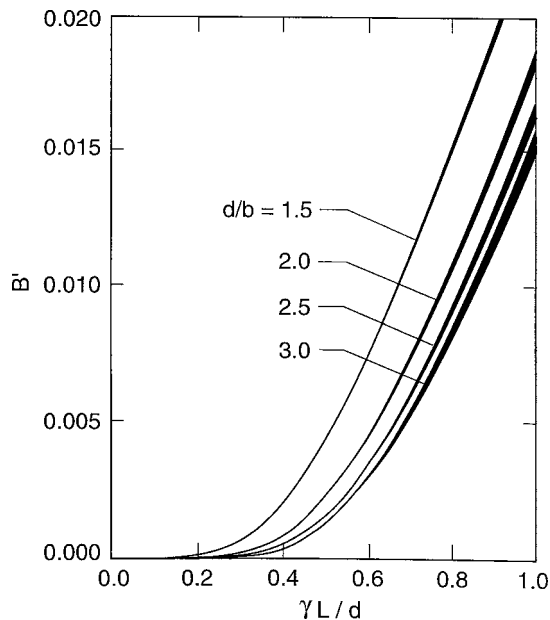

FIG. A1.2 The Coefficient B' as a Function of $\gamma L/d$ with d/b as a Parameter

A1.3 Application

A1.3.1 A review of Eq A1.6 and Eq A1.7 and Fig. A1.1 and Fig. A1.2 indicates that A' and B' are, aside from a very small dependence on hL/λ , functions of $\gamma L/d$ and d/b , or, equivalently, some other ratio of these geometrical quantities. For a given guarded hot plate, b and d are fixed and the values of A' and B' are functions only of γL (again, neglecting the weak dependence on hL/λ). The quantities multiplying A' and B' in Eq A1.6 and Eq A1.7 are, aside from a small dependence on $\gamma L/d$, functions only of hL/λ and thus do not depend on the meter area or guard plate diameters. For fixed hot- and cold-plate temperatures, the quantity X in Eq A1.1 and Eq A1.2

is a function of T_a , the ambient temperature. Thus, for a given guarded hot plate, with fixed b and d , the error due to edge heat losses or gains is dependent upon γL , hL/λ , and T_a .

A1.3.2 From Eq A1.1 and Eq A1.2, it is seen that A represents the error when the ambient temperature T_a is equal to the mean temperature of the specimen. Under ideal conditions, the temperature of half of each specimen next to the guarded hot plate is higher than the ambient resulting in a heat loss along half the specimen edge. Conversely, the other half of the specimen (next to the cold plate) experiences a heat gain from the ambient. In effect, a small fraction of the heat input to the meter plate bypasses the meter section of the specimen, resulting in an error in the computed thermal transmission properties.

A1.3.3 The quantity BX in Eq A1.1 and Eq A1.2 represents the additional error when the ambient temperature differs from the mean temperature of the test specimen. In principle, the error due to edge heat losses or gains can be eliminated by selecting an ambient temperature such that $BX = -A$, which occurs when the ambient temperature is somewhat hotter than the mean temperature of the specimen:

$$T_a = T_m + \frac{A T_h - T_c}{B} \quad (\text{A1.10})$$

A1.3.4 While this value of T_a is a good choice, relying on this selection alone as a means of adequately controlling edge heat loss or gain is usually insufficient. Simply controlling the ambient temperature to the value given by Eq A1.10 cannot adequately eliminate edge heat losses or gains unless the guard plate is sufficiently wide and the value of hL/λ is sufficiently low to ensure that both A and B are small.

NOTE A1.1—The analytical models used by Peavy and Rennex (10) and Bode (11) assume that edge heat transfer occurs across an infinitesimally thin boundary with a uniform film coefficient h and a uniform ambient temperature T_a . In actuality, the following conditions can cause the assumptions to be invalid: (1) if edge insulation is used and h is taken as the thermal conductance in the radial direction, the assumption of an infinitesimally thick boundary is not satisfied; and (2) if a secondary guard is used (see Test Method C 177), there may be heat flows in the edge insulation to regions at temperatures different than that of the secondary guard. Consequently, the basic assumptions of the analysis may not be valid.

A1.3.5 In designing a guarded hot plate, b and d can be varied in order to obtain acceptably small edge-effect errors for the specimen thermal conductivities and thicknesses of interest. Fig. A1.1 and Fig. A1.2 reveal that, for any given value of d/b , both A' and B' increase rapidly as $\gamma L/d$ increases beyond 0.3. Reducing b , the radius of the meter area, relative to d , the guard plate outer radius, significantly lowers the values of A' and B' as d/b increases from 1.5 to 2.0. However, further reduction in b does not provide much additional reduction in A' and B' . From these observations, the value of d/b should be equal to 2.0 or greater, but little additional benefit would be gained by selecting d/b greater than 2.5.

A1.3.6 Eq A1.6 and Eq A1.7 reveal that when $hL/\lambda \ll 1.0$, A and B are approximately equal to $(hL/\lambda)A'$ and $(hL/\lambda)B'$, respectively. When hL/λ is very large, A is approximately $2\pi A'$ and B is approximately $\pi B'$, corresponding to the situation where the circumferential edge of the specimen is essentially isothermal at the same temperature as that of the ambient. For

these limiting values, fixed values of b and d , and a given ambient temperature T_a , hL/λ needs to be less than 3.0 in order to reduce the edge heat loss effects to less than half of what they would be if hL/π were quite large.

A1.3.7 Using edge insulation having a thermal conductivity λ_e and thickness E , the equivalent film coefficient for the edge insulation is $h = \lambda_e/E$ and accordingly, $hL/\lambda = (\lambda_e/\lambda)(L/E)$. Assume that the edge insulation and specimen have the same thermal conductivity ($\lambda_e = \lambda$) so that $hL/\lambda = L/E$. Based upon A1.4.6, the thickness of the edge insulation should be at least one-third the thickness of the specimen in order to reduce significantly the edge effects. For example, a specimen 0.15 m thick requires at least 0.050 m of edge insulation. For thicker specimens, or an apparatus with a fixed-diameter secondary guard, it may not be possible to have the desired level of edge insulation.

A1.3.8 *Example*—Given a guarded hot plate with $d/b = 2.0$, an isotropic specimen ($\gamma = 1$) of thickness $L = 0.8d$, and edge insulation such that $hL/\lambda = 3$, the edge effects are estimated as follows. From Fig. A1.1 and Fig. A1.2, $A' = 0.0043$ and $B' = 0.11$. From these values, using Eq A1.6 and Eq A1.7, $A = 1.99A' = 0.0086$ and $B = 1.44B' = 0.16$. Thus, from Eq A1.1, $\epsilon = 0.0086 + 0.16X$. From Eq A1.10, taking $T_h - T_c = 20$ K, the ideal choice for the ambient temperature would be $T_a = T_m + 0.54$ K. Assuming that the ambient temperature can be held within ± 1 K of this value, the edge heat loss error, from Eq A1.1 and Eq A1.2, would be $\epsilon = \pm 0.016$. Thus, for the above assumptions, the edge effects could be ± 1.6 %.

A2. LOCATION OF LINE-HEAT SOURCES

A2.1 Scope

A2.1.1 This annex provides procedures based on analyses by Flynn et al. (13) for determining the radial locations of the line-heat sources. Alternative procedures than those in this annex may be used for selecting these locations, but it is the responsibility of the user to determine what, if any, corrections must be applied to measured temperatures in order to compute thermal transmission properties of test specimens. This annex provides for two general cases for the meter plate: (1) the mean temperature of the meter plate equal to the gap temperature; and (2) the mean temperature of the meter plate maximally isothermal and greater than the gap temperature. Analogous procedures are provided for the guard plate.

A2.2 Meter Plate: Case 1

A2.2.1 The procedure in this section provides the means for multiple heaters in the meter plate to be located so that the temperature at the gap will be equal to the mean temperature of the meter plate. The special case of one circular line-heat source in the meter plate is also discussed.

NOTE A2.1—The latter represents the case for plates built at the National Institute of Standards and Technology (formerly the National Bureau of Standards) as described in the adjunct.⁴

A2.2.2 The meter plate is assumed to have n circular heaters. If the effects of heater leads are neglected and the thermal conductance of the test specimens is not too high, the temperature distribution in the meter plate can be assumed to be a function only of radial position and the heat flux from the plate into the specimens can be assumed uniform. For these assumptions, the temperature at the guard gap, $r = b$, will be equal to the mean temperature averaged over the entire meter plate provided that:

$$\sum_{k=1}^n \frac{2\pi a_k q'_k}{Q} \left(\frac{2a_k^2}{b^2} - 1 \right) = 0 \quad (\text{A2.1})$$

where the k -th heater, located at $r = a_k$, produces q'_k W per unit length. The total power input to the meter plate is given by:

$$Q = \sum_{k=1}^n 2\pi a_k q'_k \quad (\text{A2.2})$$

A2.2.3 If all of the heaters carry the same current, q'_k in Eq A2.1 can be replaced by the electrical resistance per unit length of the k -th heater and Q can be replaced by the total combined electrical resistance of all of the heaters. Further, if all of the heaters have the same electrical resistance per unit length, the temperature at the guard gap can be made equal to the mean temperature of the meter plate by selecting heater locations such that:

$$\sum_{k=1}^n \frac{a_k}{b} \left(\frac{2a_k^2}{b^2} - 1 \right) = 0 \quad (\text{A2.3})$$

A2.2.4 For only one heater, the location is $a = a_1 = b \sqrt{2}/2$. If there are multiple heaters, Eq A2.3 does not have a unique solution. However, if half of the power input to each heater is constrained to flow radially inward in the meter plate and half to flow outward and the power input to the region of the meter plate between two heaters is provided only by those two heaters, a unique solution to Eq A2.3 is available. With these constraints, when the heaters are of equal strength (that is, have the same power output per unit length), they should be located at:

$$\frac{a_k}{b} = \frac{k}{\sqrt{n^2 + n}}, \text{ for } k = 1, 2, \dots, n \quad (\text{A2.4})$$

Values for a_k/b obtained from Eq A2.4 for $n \leq 6$ are listed in Table A2.1.

A2.2.5 When the heater locations have been selected such that the mean temperature of the meter plate is equal to the temperature at the gap, the radial temperature distribution $v(r)$ is given by:

$$\frac{v(r) - V}{V} = \frac{b^2}{2\lambda_p m R} \cdot F(n, r/b) \quad (\text{A2.5})$$

Here, $V = T_h - T_c$ is the mean temperature of the meter plate measured relative to the cold plates, λ_p is the thermal conductivity of the material of which the meter plate is constructed, m

TABLE A2.1 Radial Locations for Line-heat Sources in the Meter Plate, Selected so that the Gap is Equal to the Mean Temperature of the Meter Plate

<i>n</i>	<i>a</i> ₁ / <i>b</i>	<i>a</i> ₂ / <i>b</i>	<i>a</i> ₃ / <i>b</i>	<i>a</i> ₄ / <i>b</i>	<i>a</i> ₅ / <i>b</i>	<i>a</i> ₆ / <i>b</i>	<i>a</i> ₇ / <i>b</i>	<i>a</i> ₈ / <i>b</i>	<i>a</i> ₉ / <i>b</i>	<i>a</i> ₁₀ / <i>b</i>	<i>F</i> _{min}	<i>F</i> _{max}
1	0.7071	-0.3069	0.1931
2	0.4082	0.8165	-0.1324	0.0721
3	0.2887	0.5774	0.8660	-0.0758	0.0377
4	0.2236	0.4472	0.6708	0.8944	-0.0497	0.0231
5	0.1826	0.3651	0.5477	0.7303	0.9129	-0.0354	0.0157
6	0.1543	0.3086	0.4629	0.6172	0.7715	0.9258	-0.0266	0.0113
7	0.1336	0.2673	0.4009	0.5345	0.6682	0.8018	0.9354	-0.0208	0.0085
8	0.1179	0.2357	0.3536	0.4714	0.5893	0.7071	0.8250	0.9428	-0.0168	0.0067
9	0.1054	0.2108	0.3162	0.4216	0.5270	0.6325	0.7379	0.8433	0.9487	...	-0.0138	0.0054
10	0.953	0.1907	0.2860	0.3814	0.4767	0.5721	0.6674	0.7628	0.8581	0.9535	-0.0116	0.0044

is the thickness of the meter plate, and *R* is the thermal resistance of the specimens. The function *F* is given by:

$$F(n,r/b) = \frac{r^2}{b^2} - 1 - \frac{4}{n^2 + n} \sum_{k=1}^n k \ln\left(\frac{r_k}{b}\right) \quad (A2.6)$$

where *r*_{k>} is the greater of *r* or *a*_{*k*} (that is, *r*_{k>} = *a*_{*k*} when *r* < *a*_{*k*} and *r*_{k>} = *r* when *r* > *a*_{*k*}). Eq A2.5 requires two specimens each having the same thermal resistance. If the specimens have different resistances *R*₁ and *R*₂, *R* in Eq A2.5 becomes 2*R*₁*R*₂/(*R*₁ + *R*₂). If the guarded-hot-plate apparatus is operated in the single-sided mode, with only one specimen, the right hand side of Eq A2.5 should be divided by two.

A2.2.6 Fig. A2.1 shows the function *F*(*n*,*r*/*b*) for values of *n* ranging from 1 to 4. For each value of *n* this function has its lowest value, *F*_{min}, at the center of the meter plate and local maxima, *F*_{max}, being at the location of each heater, with the highest value, *F*_{max}, being at the outermost heater. The values of *F*_{min} and *F*_{max} are included in Table A2.1. These values can be used in conjunction with Eq A2.5 to compute the range of temperature variation for a given meter plate and specimens.

A2.2.7 Example 1—Assume that the meter plate has a radius of 0.1 m, a thickness of 0.005 m, and a thermal

conductivity of 200 W/m·K. For a pair of specimens, each having a thermal resistance of 0.5 m²·K/W, Eq A2.5 yields:

$$\frac{v(r) - V}{V} = 0.01 \cdot F(n,r/b) \quad (A2.7)$$

For a meter plate with a single line-heat source and this set of parameters, the temperature of the meter plate, relative to the temperature of the cold plates, would be 0.3 % colder than the mean temperature in the center and 0.2 % hotter at the heater location. If three heaters were used, the center temperature would be 0.08 % colder and the maximum temperature 0.04 % hotter than the mean temperature.

A2.2.8 Example 2—Consider a meter plate having a radius of 0.05 m, a thickness of 0.005 m, and a thermal conductivity of 50 W/m·K used to test specimens having a thermal resistance of only 0.05 m²·K/W. The factor multiplying *F* in Eq A2.5 would be 0.1. If a single heater were used, the temperature at the center of the meter plate would be 3.1 % colder than the mean temperature and the temperature at the location of the heater would be 1.9 % hotter. Thus, for high-conductance specimens, the user may decide to build the meter plate with four line-heat sources so that the extreme temperatures would be only -0.5 % and +0.2 % different from the mean temperature.

A2.3 Meter Plate: Case 2

A2.3.1 The procedure in this section provides the means for heater locations that result in the meter plate being more isothermal than if heater locations had been determined using the procedure in A2.2. However, this improved temperature uniformity is obtained at the expense of either locating the temperature sensors somewhat inboard of the outer edge of the meter plate or else making a small correction to the gap temperature in order to obtain the mean temperature of the meter plate. As was the case in A2.2, it is assumed that the heaters all have the same electrical resistance per unit length and carry the same current.

A2.3.2 An iterative procedure is required to determine the location of the heaters so that a simple equation cannot be used to compute the values of *a*_{*k*}/*b*, as was done in A2.2. The radial locations are given in Table A2.2, for the cases of 1 to 6 heaters. The values shown for *r*_{meas}/*b* indicate the largest radius at which the local temperature of the plate is equal to its mean temperature. This is a location at which temperature sensors

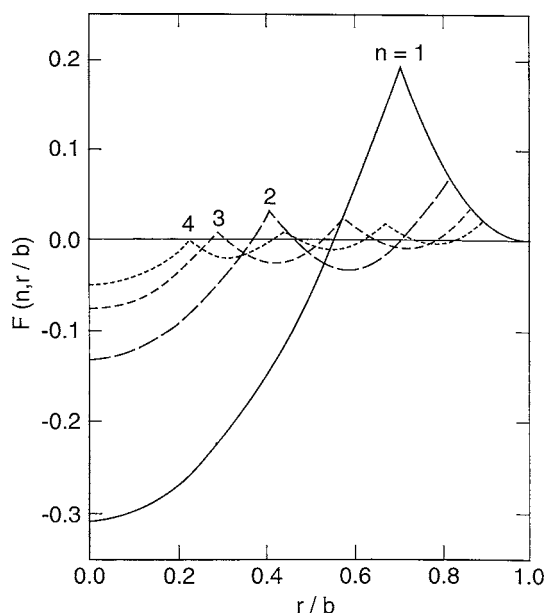

FIG. A2.1 The Function *F*(*n*,*r*/*b*) for the Meter Plate, Plotted versus *r*/*b* with *n* as a Parameter

TABLE A2.2 Radial Locations for Line Heat-Sources in the Meter Plate, Selected so that the Meter Plate is as Isothermal as Possible

<i>n</i>	<i>a</i> ₁ / <i>b</i>	<i>a</i> ₂ / <i>b</i>	<i>a</i> ₃ / <i>b</i>	<i>a</i> ₄ / <i>b</i>	<i>a</i> ₅ / <i>b</i>	<i>a</i> ₆ / <i>b</i>	<i>a</i> ₇ / <i>b</i>	<i>a</i> ₈ / <i>b</i>	<i>a</i> ₉ / <i>b</i>	<i>a</i> ₁₀ / <i>b</i>	<i>r</i> _{meas} / <i>b</i>	<i>G</i> _{min}	<i>G</i> _{max}
1	0.6459	0.8039	-0.2086	0.2086
2	0.3535	0.7909	0.8820	-0.0625	0.0656
3	0.2464	0.5480	0.8529	0.9163	-0.0303	0.0313
4	0.1888	0.4203	0.6530	0.8864	0.9352	-0.0178	0.0183
5	0.1531	0.3408	0.5296	0.7183	0.9074	0.9471	-0.0117	0.0120
6	0.1288	0.2867	0.4454	0.6042	0.7629	0.9219	0.9553	-0.0083	0.0085
7	0.1111	0.2474	0.3844	0.5213	0.6583	0.7953	0.9325	0.9613	-0.0062	-0.0063
8	0.0977	0.2175	0.3380	0.4585	0.5790	0.6994	0.8199	0.9405	0.9659	-0.0048	-0.0049
9	0.0872	0.1941	0.3017	0.4092	0.5167	0.6264	0.7317	0.8392	0.9468	...	0.9695	-0.0038	-0.0039
10	0.0788	0.1753	0.2724	0.3694	0.4665	0.5636	0.6606	0.7577	0.8548	0.9519	0.9724	-0.0031	-0.0032

can be located if one does not wish to have to make a (small) correction to the measured temperature in order to obtain the mean temperature.

A2.3.3 When the heater locations have been selected from the values in Table A2.2, the radial temperature distribution is given by Eq A2.5, but with *F*(*n,r/b*) replaced by *G*(*n,r/b*), the function shown in Fig. A2.2. For *n* = 1 to 6, the minimum and maximum values of *G*(*n,r/b*) are given in Table A2.2. The examples given previously in A2.2.7 and A2.2.8 can easily be adapted to the modified heater locations by replacing values of *F* with the corresponding values of *G*.

A2.4 Guard Plate: Case 1

A2.4.1 The procedure in this section provides the means for multiple heaters in the guard plate to be located so that half of the heat input to a given heater flows inward in the guard plate while half flows outward.

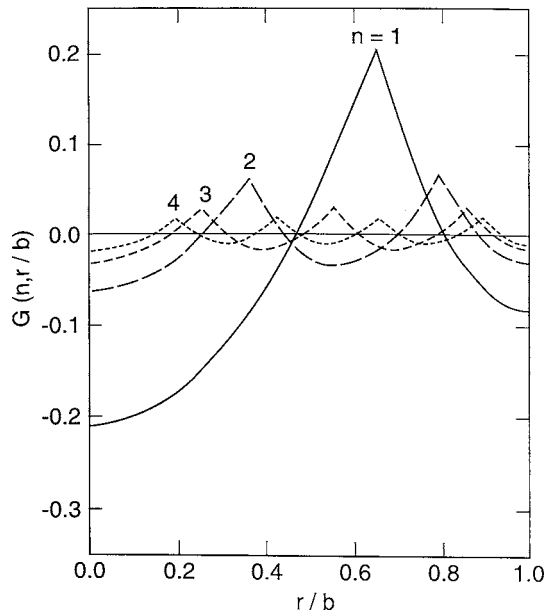

FIG. A2.2 The Function *G*(*n,r/b*) for the Meter Plate, Plotted versus *r/b* with *n* as a Parameter

A2.4.2 The temperature distribution in the guard plate depends upon the inner and outer diameters of the guard ring, the heater locations, and the amount of heat loss from the edge of the guard plate. Normally, the edge heat losses would not be negligible when specimens having high thermal resistance are tested. In a well-designed guarded hot plate, the radial temperature variations for such specimens would be so small that optimal location of the heaters would not be critical. For specimens with very low thermal resistance, edge heat loss would not have much effect on the selection of heater locations, provided that reasonably good edge insulation were used and the ambient temperature did not differ too greatly from the guard plate edge temperature. For this reason, the heater locations given in this section and in A2.5 have been computed assuming that edge heat losses are negligible compared to the heat flow through the test specimen(s).

NOTE A2.2—For a specific guarded-hot-plate design, a particular edge heat loss can be assumed and the corresponding optimal heater locations computed for specimens having the lowest thermal resistance of interest. A better procedure would be to compute the heater locations as is done in this section and in A2.5, that is, assuming that there is no edge heat loss, and then to design and build the guarded-hot-plate apparatus with an edge heater on the guard plate that can be adjusted to provide essentially all of the heat that is lost to the ambient.

A2.4.3 Given the same constraints as in A2.2.3, that is, *n* heaters of equal strength per unit length located so that half of the heat input to a given heater flows inward in the guard plate while half flows outward, the *k*-th heater should be located at a radius *c_k*, given by:

$$\frac{c_k}{b} = \frac{c_1}{b} \left[1 + (k - 1) \left(1 - \frac{b^2}{c_1^2} \right) \right] \tag{A2.8}$$

where *b* is the inner radius of the guard plate and *c*₁ is the location of the innermost heater, with *c*₁/*b* given by the real, positive root of:

$$(n^2 + n) \frac{c_1^4}{b^4} - \left(\frac{d^2}{b^2} + 2n^2 - 1 \right) \frac{c_1^2}{b^2} + (n^2 - n) = 0 \tag{A2.9}$$

Since Eq A2.9 is quadratic in *c*²/*b*², the root is easily obtained. Values for *c_k*/*b*, obtained from Eq A2.8 and Eq A2.9, for *d/b* = 1.5, 2.0, 2.5, and 3.0 and *n* ≤ 6 are listed in Table A2.3.

TABLE A2.3 Radial Locations for Line-heat Sources in the Guard Plate, Selected so that Half of the Heat Input to a Given Heater Flows Inward in the Guard Plate While Half Flows Outward

d/b	n	c_1/b	c_2/b	c_3/b	c_4/b	c_5/b	c_6/b	c_7/b	c_8/b	c_9/b	c_{10}/b
1.5	1	1.2748
	2	1.1321	1.3808
	3	1.0866	1.2529	1.4192
	4	1.0644	1.1892	1.3140	1.4389
	5	1.0512	1.1511	1.2510	1.3510	1.4509
	6	1.0425	1.1258	1.2091	1.2924	1.3757	1.4589
	7	1.0363	1.1077	1.1791	1.2505	1.3219	1.3933	1.4647
	8	1.0317	1.0942	1.1567	1.2192	1.2816	1.3441	1.4066	1.4691
	9	1.0282	1.0837	1.1392	1.1948	1.2503	1.3059	1.3614	1.4169	1.4752	...
	10	1.0253	1.0753	1.1253	1.1753	1.2253	1.2753	1.3252	1.3752	1.4252	1.4752
2.0	1	1.5811
	2	1.2762	1.7688
	3	1.1791	1.5102	1.8413
	4	1.1322	1.3813	1.6303	1.8794
	5	1.1047	1.3042	1.5037	1.7032	1.9027
	6	1.0866	1.2530	1.4194	1.5858	1.7522	1.9185
	7	1.0739	1.2166	1.3592	1.5019	1.6446	1.7873	1.9299
	8	1.0644	1.1893	1.3141	1.4390	1.5639	1.6888	1.8137	1.9385
	9	1.0571	1.1681	1.2791	1.3901	1.5012	1.6122	1.7232	1.8342	1.9453	...
	10	1.0512	1.1512	1.2511	1.3510	1.4510	1.5509	1.6508	1.7508	1.8507	1.9057
2.5	1	1.9039
	2	1.4302	2.1611
	3	1.2771	1.7711	2.2652
	4	1.2034	1.5758	1.9483	2.3207
	5	1.1604	1.4591	1.7578	2.0564	2.3551
	6	1.1323	1.3816	1.6308	1.8800	2.1293	2.3785
	7	1.1126	1.3264	1.5402	1.7540	1.9678	2.1816	2.3954
	8	1.0980	1.2851	1.4723	1.6595	1.8466	2.0338	2.2210	2.4082
	9	1.0867	1.2531	1.4195	1.5860	1.7524	1.9189	2.0853	2.2517	2.4182	...
	10	1.077	1.2276	1.3774	1.5272	1.6770	1.8269	1.9767	2.1265	2.2764	2.4262
3.0	1	2.2361
	2	1.5922	2.5564
	3	1.3799	2.0351	2.6902
	4	1.2777	1.7727	2.2677	2.7627
	5	1.2183	1.6157	2.0131	2.4105	2.8079
	6	1.1796	1.5114	1.8432	2.1750	2.5069	2.8397
	7	1.1525	1.4372	1.7220	2.0067	2.2915	2.5762	2.8610
	8	1.1324	1.3818	1.6311	1.8805	2.1298	2.3792	2.6286	2.8779
	9	1.1170	1.3388	1.5606	1.7823	2.0041	2.2259	2.4476	2.6694	2.8912	...
	10	1.1048	1.3045	1.5041	1.7038	1.9035	2.1032	2.3028	2.5025	2.7022	2.9018

A2.5 Guard Plate: Case 2

A2.5.1 The heater locations given in this section result in the guard plate being somewhat more isothermal than it would be for the heater locations determined using the procedure in A2.4. As was the case in A2.4, it is assumed that the effects of edge heat losses can be neglected and that the heaters all have the same electrical resistance per unit length and carry the same

current. An iterative procedure, or the solution of a family of equations, is required to determine the location of the heaters so that a simple equation cannot be used to compute the values of c_k/b , as was done in the previous section. The heater locations obtained by iteration are given in Table A2.4, for the cases of 1 to 6 heaters, for four different values of d/b .

TABLE A2.4 Radial Locations for Line-heat Sources in the Guard Plate, Selected so that the Plate is as Isothermal as Possible

d/b	n	c_1/b	c_2/b	c_3/b	c_4/b	c_5/b	c_6/b	c_7/b	c_8/b	c_9/b	c_{10}/b
1.5	1	1.2626
	2	1.1279	1.3773
	3	1.0847	1.2509	1.4177
	4	1.0633	1.1881	1.3130	1.4381
	5	1.0505	1.1504	1.2504	1.3503	1.4504
	6	1.0420	1.1253	1.2086	1.2919	1.3752	1.4586
	7	1.0360	1.1073	1.1788	1.2502	1.3216	1.3930	1.4645
	8	1.0314	1.0939	1.1564	1.2189	1.2814	1.3439	1.4064	1.4689
	9	1.0279	1.0835	1.1390	1.1946	1.2501	1.3057	1.3612	1.4168	1.4723	...
	10	1.0251	1.0751	1.1251	1.1751	1.2251	1.2751	1.3251	1.3751	1.4251	1.4751
2.0	1	1.5425
	2	1.2609	1.7576
	3	1.1719	1.5034	1.8366
	4	1.1280	1.3771	1.6268	1.8768
	5	1.1020	1.3014	1.5013	1.7011	1.9011
	6	1.0847	1.2510	1.4176	1.5842	1.7507	1.9174
	7	1.0724	1.2150	1.3579	1.5006	1.6434	1.7862	1.9291
	8	1.0633	1.1881	1.3131	1.4380	1.5630	1.6879	1.8129	1.9379
	9	1.0562	1.1671	1.2782	1.3893	1.5004	1.6115	1.7226	1.8336	1.9448	...
	10	1.0505	1.1504	1.2504	1.3503	1.4503	1.5503	1.6503	1.7503	1.8502	1.9503
2.5	1	1.8331
	2	1.3984	2.1399
	3	1.2615	1.7572	2.2562
	4	1.1942	1.5671	1.9412	2.3158
	5	1.1544	1.4531	1.7527	2.0522	2.3521
	6	1.1281	1.3772	1.6270	1.8767	1.1264	2.3764
	7	1.1094	1.3231	1.5373	1.7514	1.9655	2.1796	2.3939
	8	1.0955	1.2826	1.4700	1.6574	1.8447	2.0321	2.2195	2.4070
	9	1.0847	1.2510	1.4177	1.5842	1.7508	1.9174	2.0840	2.2506	2.4173	...
	10	1.0761	1.2259	1.3758	1.5258	1.6757	1.8256	1.9756	2.1255	2.2754	2.4255
3.0	1	2.1308
	2	1.5400	2.5237
	3	1.3534	1.0123	2.6764
	4	1.2617	1.7580	2.2561	2.7552
	5	1.2077	1.6055	1.0046	2.4035	2.8032
	6	1.1721	1.5040	1.8368	2.1696	2.5023	2.8355
	7	1.1469	1.4315	1.7170	2.0023	2.2877	2.5730	2.8587
	8	1.1281	1.3773	1.6271	1.8769	2.1267	2.3764	2.6262	2.8762
	9	1.1136	1.3352	1.5573	1.7793	2.0014	2.2235	2.4455	2.6676	2.8898	...
	10	1.1020	1.3015	1.5014	1.7013	1.9012	2.1011	2.3010	2.5008	2.7007	2.9007

APPENDIXES

(Nonmandatory Information)

X1. ESTIMATION OF HEAT FLOW ACROSS THE GAP

X1.1 Scope

X1.1.1 This appendix provides analyses of heat flow for three gap cross-sections: (a) rectangular; (b) circular; and, (c) diamond-shaped (Fig. 2). The analyses for the following geometries have been derived by Hahn (2, 3).

X1.2 Gap of Rectangular Cross-Section

X1.2.1 The heat flow across the gap in Fig. 2(a) is simply:

$$Q_g \approx \frac{2\pi b m \lambda_g V_0}{w} \quad (X1.1)$$

where V_0 is the temperature difference across the gap, λ_g is the thermal conductivity of insulation in the gap, m is the plate thickness, b is the radius to the center of the gap, and w is the width of the gap.

X1.3 Gap of Circular Cross-Section

X1.3.1 As shown by Hahn et al. (3), the heat flow across the gap in Fig. 2(b) is:

$$Q_g \approx \frac{2\pi b m \lambda_g V_0}{w} \left[\frac{m - 2R}{m} + \frac{8R}{\pi m} \sum_{n=1}^{\infty} \frac{1}{n^2} \sin\left(\frac{nw}{2R}\right) \right] \quad (X1.2)$$

where R is the radius of the circular cross-section. The first term in Eq X1.2 represents heat flow across the narrow portions of the gap near the surfaces of the plate, while the second term represents heat flow across the circular region.

X1.4 Gap of Diamond-Shaped Cross-Section

X1.4.1 As shown by Hahn et al. (3), the total heat flow across the gap in Fig. 2(c) is:

$$Q_g \approx \frac{2\pi b m \lambda_g V_0}{w} \left[\frac{m - 2R}{m} + \frac{8w}{\pi m} \sum_{n=1,3,5,\dots}^{\infty} \frac{1}{n} \left\{ \operatorname{cosech}(n\pi) \cosh \frac{n\pi w}{2R+w} - \coth(n\pi) \cos \frac{2n\pi R}{2R+w} \right\} \right] \quad (\text{X1.3})$$

Here, $2R$ is the vertical distance of the meter plate subtended by the angle of the diamond-shaped cross-section (see Fig. 2(c)).

X1.5 Other Considerations

X1.5.1 If the temperature across the gap is imbalanced, other factors affecting the heat flow across the gap should be considered, including: (1) conduction heat transfer across the air gap; (2) conduction through the meter plate support system (metal pins, for example); (3) conduction through sensor wires that cross the gap; (4) conduction through the wire heater leads that cross the gap; and (5) radiation heat transfer across the gap. For further details, the user is referred to Hahn's dissertation (2).

X2. ANGULAR LOCATION OF HEATER LEADS AND TEMPERATURE SENSORS

X2.1 Scope

X2.1.1 This appendix provides a method for locating the angular positions of the heater leads and temperature sensors in the gap. The analysis presented here has been derived by Hahn (2) utilizing Green's functions to describe the generation of heat due to the heater leads.

NOTE X2.1—The analysis presented in Annex A2 is based on ideal temperature distributions, independent of angle. In actuality, this symmetry in a line-heat-source guarded hot plate can be disturbed by the (joulean) heat generated from the wire leads to the heaters in the meter and guard plates. These effects are generally small but can be determined by application of Green's functions.

X2.2 Theoretical Analysis

X2.2.1 *Geometric Model*—A meter plate of thickness m , radius b_1 , and thermal conductivity λ_p has a single line-heat

source at radius a as illustrated in Fig. X2.1. For the analysis, an r, θ, z cylindrical coordinate system is utilized. The lead wires for the heater enter the meter plate radially at the half-angle, α . The heat generation per unit length for the lead wires is q_1' ; for the portion of the heater between $-\alpha < \theta < \alpha$, q_2' ; and the remaining portion, q_3' .

X2.2.2 *Assumptions*—The analysis is based on the following assumptions (1) axial heat flow in the guarded hot plate can be neglected; (2) radial and angular heat flow in the specimen can be neglected; (3) the heat flux from both sides of the guarded hot plate is uniform; (4) there is no heat flow across the gap; and, (5) heat is generated only in circular line-line heat sources or heater leads normal to the sources.

X2.2.3 Meter Plate—As shown by Hahn et al. (2), the solution for the meter plate for $r = b_1$ is:

$$\begin{aligned}
 v(b_1, \theta) = & \frac{q'_1}{2\pi m \lambda_p} \left[\frac{b_1^3 - a^3}{3b_1^2} + \frac{7}{2}(b_1 - a) \right. \\
 & - b_1(1 - \cos(\theta - \alpha)) \ln(2 - 2\cos(\theta - \alpha)) \\
 & - b_1(1 - \cos(\theta + \alpha)) \ln(2 - 2\cos(\theta + \alpha)) \\
 & + (a - b_1 \cos(\theta - \alpha)) \ln \left(1 - 2 \frac{a}{b_1} \cos(\theta - \alpha) + \frac{a^2}{b_1^2} \right) \\
 & + \left(a - b_1 \cos(\theta + \alpha) \right) \ln \left(1 - 2 \frac{a}{b_1} \cos(\theta + \alpha) + \frac{a^2}{b_1^2} \right) \\
 & - 2b_1 \sin(\theta - \alpha) \left(\tan^{-1} \frac{1 - \cos(\theta - \alpha)}{\sin(\theta - \alpha)} \right. \\
 & \left. - \tan^{-1} \frac{a - b_1 \cos(\theta - \alpha)}{b_1 \sin(\theta - \alpha)} \right) \\
 & - 2b_1 \sin(\theta + \alpha) \left(\tan^{-1} \frac{1 - \cos(\theta + \alpha)}{\sin(\theta + \alpha)} \right. \\
 & \left. - \tan^{-1} \frac{a - b_1 \cos(\theta + \alpha)}{b_1 \sin(\theta + \alpha)} \right) \left. \right] \\
 & + \frac{a}{\pi m \lambda_p} [q'_2 \alpha + q'_3 (\pi - \alpha)] \left(\frac{b_1^2 + a^2}{2b_1^2} - \frac{3}{4} \right) \\
 & + \frac{2a}{\pi m \lambda_p} (q'_2 - q'_3) \sum_{n=1}^{\infty} \frac{1}{n^2} \left(\frac{a}{b_1} \right)^n \sin n \alpha \cos n \theta + \bar{V}_m
 \end{aligned}
 \tag{X2.1}$$

where v is the temperature and V_m is the average temperature of the meter plate.

X2.2.4 Example—Choosing $a = b_1 \sqrt{2} / 2$, $\alpha = 0$, and $q'_2 - q'_3 = 0$, Eq X2.1 becomes:

$$\begin{aligned}
 v(b_1, \theta) = & \frac{q'_1 b_1}{\pi m \lambda_p} \left[\frac{23}{12} - \frac{11}{6} \frac{a}{b_1} - (1 - \cos \theta) \ln(2 - 2 \cos \theta) \right. \\
 & + \left(\frac{a}{b_1} - \cos \theta \right) \ln \left(\frac{3}{2} - 2 \frac{a}{b_1} \cos \theta \right) \\
 & \left. - 2 \sin \theta \left(\tan^{-1} \frac{1 - \cos \theta}{\sin \theta} - \tan^{-1} \frac{a/b_1 - \cos \theta}{\sin \theta} \right) \right] + \bar{V}_m
 \end{aligned}
 \tag{X2.2}$$

Further substituting for $q'_1 = \rho_1 \pi i^2 = 0.029 i^2$ W/m, $\lambda_p = 370$ W/(m·K), $b_1 = 75.79$ mm and $m = 9.53$ mm allows plotting $(v(b_1, \theta) - V_m)/i^2$ versus θ . For $v(b_1, \theta) - V_m = 0$, $\theta_{1,2} = 69^\circ$ and 291° . Thus, temperature sensors on the meter-plate side of the gap would be located at these two positions. A similar computation (2) is performed to determine the angles for the guard-plate side of the gap.

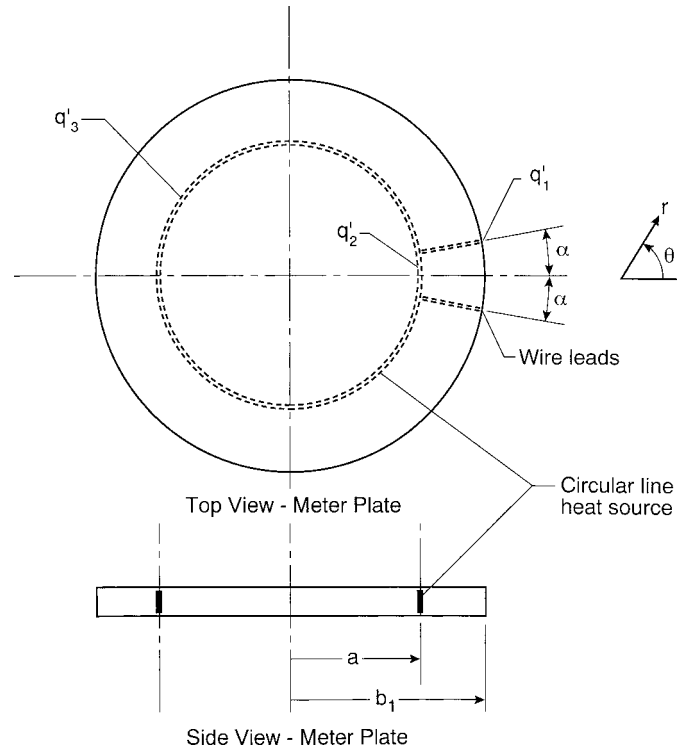

FIG. X2.1 Geometry Used in the Analysis of Angular Temperature Distribution at the Gap

X3. COMMENTARY

X3.1 Introduction

X3.1.1 This commentary provides the user of this practice with its background and history. It includes a brief discussion on the precision and bias of the line-heat-source guarded hot plate.

X3.1.2 The guarded-hot-plate apparatus and its application in determining the steady-state thermal transmission properties of flat specimens are covered in Test Method C 177. The test method permits different designs for the apparatus and, in principle, includes apparatus designed with guarded hot plates having either distributed- or line-heat sources.

X3.1.3 A guarded hot plate with a distributed heat source typically utilizes a core heater of wire or ribbon distributed over a square or circular core plate and laminated between two thermally conductive surface plates. In most cases, the surface plates are metal and are insulated electrically from the heater windings.

X3.1.4 Considerable difficulty is encountered in assessing the errors associated with this type of apparatus (14). A square plate geometry can further complicate the thermal balance at the guard due to the effects of corners. Also, a laminated construction using materials having differential thermal expansions may warp or deform permanently after thermal cycling.

X3.1.5 In contrast, a guarded hot plate with circular line-heat sources typically utilizes one (or a few) heaters embedded at fixed locations in a monolithic plate having a high thermal conductivity. A plate having a circular geometry simplifies the mathematical analysis permitting the temperature profile and mean surface temperature of the meter plate to be calculated.

X3.1.6 The main benefit of the line-heat-source design is that the temperature distribution in the meter plate can be accurately predicted. Thus, it is not necessary to install temperature sensors in the central region of the meter plate. The mean surface temperature of the meter plate is measured

with one (or a few) temperature sensors located at the edge of the meter plate in the gap.

X3.1.7 Other benefits due to the circular plate geometry include simplification of the mathematical analysis of edge heat losses (or gains) as well as facilitating the temperature balance of the gap between the meter and guard plates. The monolithic construction of the guarded hot plate facilitates fabrication and repair of the plate.

X3.2 History of Practice C 1043

X3.2.1 In 1964, H. E. Robinson presented the basic design of the line-heat-source guarded hot plate to a thermal conductivity conference sponsored by the National Physical Laboratory in England. Tye (1) reported:

H. E. Robinson (U.S. National Bureau of Standards) discussed forms of line heat sources that could be used as heaters in apparatus for measurements at lower temperatures on insulating materials in disk and slab form. These new configurations lend themselves more readily to mathematical analysis; they are more simple to use and would appear to be able to yield more accurate results.

X3.2.2 In 1971, Hahn (2) conducted an in-depth analysis of the line-heat-source concept and investigated several design options. Subsequently, in 1973, the design, mathematical analysis, and uncertainty analysis for an apparatus under construction at the National Bureau of Standards (now NIST) were presented at an ASTM symposium on Heat Transmission Measurements in Thermal Insulations (3). A final description of this apparatus was presented by Siu (5) in 1981. Favorable test results resulted in the construction at NIST of a second larger line-heat-source guarded hot plate apparatus (7), which has subsequently been used for the development of NIST SRMs 1449 – Fumed Silica Board, 1450c – Fibrous Glass Board, and 1453 – Expanded Polystyrene Board.

X3.2.3 In 1985, the practice for using a line-heat-source in a guarded hot plate was adopted by the American Society for

Testing and Materials with a (minor) revision made in 1989. In 1996, the practice was revised extensively with changes in title and scope with minor revisions in 1997 and in 2006.

X3.3 Precision and Bias

X3.3.1 A statement on precision and bias for guard-hot-plate apparatus is covered in Test Method C 177. Currently, the statement does not distinguish between types of apparatus, line-heat-source or otherwise. The user is directed instead to the intra- and interlaboratory tests reported as follows if information on precision and bias is required.

X3.3.2 *Guarded Hot Plate Temperature Distribution*—For the NIST 305 mm line-heat-source guarded hot plate, Peavy's analysis (3) for a perfectly balanced gap predicts that the maximum temperature at the heater is 0.03°C above that at the center of the meter plate. Experimental verification by Siu (5) shows the temperature at the heater to be 0.2°C higher than the center of the meter plate. This difference, however, was equal to the uncertainty in the temperature measurements.

X3.3.3 *Intralaboratory Tests*—In 1981, Siu (6) presented results of a within-laboratory comparison of distributed- and line-heat-source guarded hot plates. The maximum deviations of the measured results for a pair of fibrous-glass board specimens were less than one percent from the SRM 1450 curve for the temperature range – 10 to 80°C.

X3.3.4 *Interlaboratory Tests*—From 1985 to 2006, the NIST 1-meter line-heat-source guarded hot plate has participated in five (published) interlaboratory tests. The first, in 1985, was sponsored by the American Society for Testing and Materials and the Mineral Insulation Manufacturers Association (15); the second on loose-fill insulations by ASTM Committee C16 with eleven laboratories (16); and third also on loose-fill insulation by ASTM Committee C16 with nine laboratories (17) the fourth with NRC-Canada (18); and, the fifth with four other national metrology institutes (19).

REFERENCES

- (1) Tye, R. P., *Nature*, Vol 204, 1964, p. 636.
- (2) Hahn, M. H., *The Line Source Guarded Hot Plate for Measuring the Thermal Conductivity of Building and Insulating Materials*, Ph.D. dissertation, Catholic University of America, 1971, available as Microfilm No. 72-17633 from University Microfilm International, 300 N. Zeeb Road, Ann Arbor, MI, 48106.
- (3) Hahn, M. H., Robinson, H., and Flynn, D., "Robinson Line-Heat-Source Guarded Hot Plate Apparatus," *Heat Transmission Measurements in Thermal Insulations*, ASTM STP 544, 1974, pp. 167–192.
- (4) Powell, F. J., and Siu, M. C. I., "Development of the Robinson Line-Heat-Source Guarded-Hot-Plate Apparatus for Measurement of Thermal Conductivity," *Proceedings of XIV International Congress of Refrigeration*, International Institute of Refrigeration, Moscow, 1975.
- (5) Siu, M. C. I., and Bulik, C., "National Bureau of Standards Line-Heat-Source Guarded-Hot-Plate Apparatus," *Review of Scientific Instruments*, Vol 52, No. 11, 1981, pp. 1709–1716.
- (6) Siu, M. C. I., "Comparison of Results of Measurements Made on a Line-Heat-Source and a Distributed-Heat-Source Guarded-Hot-Plate Apparatus," *Proceedings of the 17th Conference on Thermal Conductivity*, 1983, pp. 413–426.
- (7) Powell, F. J., and Rennex, B. G., "The NBS Line-Heat-Source Guarded Hot Plate for Thick Materials," *Proceedings of the ASHRAE/DOE Conference on Thermal Performance of Exterior Envelopes of Buildings II, Las Vegas*, ASHRAE SP 38, ASHRAE, Atlanta, GA, 1983, pp. 657–672.
- (8) Rennex, B. G., "Error Analysis for the NBS 1016 mm Guarded Hot Plate," *Journal of Thermal Insulation*, Vol 7, 1983, pp. 18–51.
- (9) Zarr, R. R., "A History of Testing Heat Insulators at the National Institute of Standards and Technology," *ASHRAE Transactions*, Vol. 107, Pt. 2, 2001, pp. 661–671.
- (10) Peavy, B., and Rennex, B. G., "Circular and Square Edge Effect Study for Guarded-Hot-Plate and Heat-Flow-Meter Apparatuses," *Journal of Thermal Insulation*, Vol 9, 1986, pp. 254–300.
- (11) Bode K. H., "Thermal Conductivity Measurements with the Plate Apparatus: Influence of the Guard Ring Width on the Accuracy of Measurements," *Guarded Hot Plate and Heat Flow Meter Methodology*, ASTM STP 879, C. J. Shirliffe and R. P. Tye, Eds., American Society for Testing and Materials, Philadelphia, 1985, pp. 29–48.
- (12) ASTM Committee E-20, *Manual on the Use of Thermocouples in Temperature Measurement*, ASTM Manual Series: MNL 12, ASTM, 1993.
- (13) Flynn, D. R., Healy, W. M., and Zarr, R. R., "High Temperature Guarded Hot Plate Apparatus - Optimal Locations of Circular Heaters," *Thermal Conductivity 28/Thermal Expansion 16*, DEStech Publications, Inc., Lancaster, PA., 2006, pp. 466–477.
- (14) Pratt, A. W., in *Thermal Conductivity*, Vol 1, R. P. Tye, Ed., 1969, p. 301.
- (15) Hust J. G., and Pelanne, C. M., "Round Robins on the Apparent Thermal Conductivity of Low-Density Glass Fiber Insulations Using Guarded Hot Plate and Heat Flow Meter Apparatus," NBSIR 85-3026, National Bureau of Standards, Boulder CO, May 1985.
- (16) Adams, R. D., and Hust, J. G., "A Round Robin on Apparent Thermal Conductivity of Several Loose-Fill Insulations," *Insulation, Materials, Testing, and Applications*, ASTM STP 1030, D. L. McElroy and J. F. Kimpflen, Eds., 1990, pp. 263–289.
- (17) McCaa, D. J., and Smith, D. R., "Interlaboratory Comparison of the Apparent Thermal Conductivity of a Fibrous Batt and Four Loose-Fill Insulations," *Insulation Materials: Testing and Applications, 2nd Volume*, ASTM STP 1116, R. S. Graves and D. C. Wysocki, Eds., 1991, pp. 534–557.
- (18) Zarr, R. R., Kumaran, M. K., and Lagergren, E. S., "NIST/NRC-Canada Interlaboratory Comparison of Guarded Hot Plate Measurements: 1993-1997," NISTIR 6087, December 1997.
- (19) Zarr, R. R., and Filliben, J. J., "International Comparison of Guarded Hot Plate Apparatus Using National and Regional Reference Materials," NIST Technical Note 1444, May 2002.

ASTM International takes no position respecting the validity of any patent rights asserted in connection with any item mentioned in this standard. Users of this standard are expressly advised that determination of the validity of any such patent rights, and the risk of infringement of such rights, are entirely their own responsibility.

This standard is subject to revision at any time by the responsible technical committee and must be reviewed every five years and if not revised, either reapproved or withdrawn. Your comments are invited either for revision of this standard or for additional standards and should be addressed to ASTM International Headquarters. Your comments will receive careful consideration at a meeting of the responsible technical committee, which you may attend. If you feel that your comments have not received a fair hearing you should make your views known to the ASTM Committee on Standards, at the address shown below.

This standard is copyrighted by ASTM International, 100 Barr Harbor Drive, PO Box C700, West Conshohocken, PA 19428-2959, United States. Individual reprints (single or multiple copies) of this standard may be obtained by contacting ASTM at the above address or at 610-832-9585 (phone), 610-832-9555 (fax), or service@astm.org (e-mail); or through the ASTM website (www.astm.org).