



# Standard Test Methods for Physical Testing of Quicklime, Hydrated Lime, and Limestone<sup>1</sup>

This standard is issued under the fixed designation C 110; the number immediately following the designation indicates the year of original adoption or, in the case of revision, the year of last revision. A number in parentheses indicates the year of last reapproval. A superscript epsilon ( $\epsilon$ ) indicates an editorial change since the last revision or reapproval.

*This standard has been approved for use by agencies of the Department of Defense.*

## 1. Scope\*

1.1 These test methods cover physical testing of quicklime and hydrated lime, and of limestone not otherwise covered in ASTM standards.<sup>2</sup>

NOTE 1—Quicklime and hydrated lime have a high affinity for moisture and carbon dioxide. Caution should be taken to protect both hydrated and quicklime during sampling, storage, and testing (see Practice C 50).

1.2 The test procedures appear in the following order:

	Section
Air Entrainment	8
Apparent Loose Density of Hydrated Lime, Pulverized Quicklime, and Limestone	20
Apparent Packed Density of Hydrated Lime, Pulverized Quicklime, and Limestone	21
Autoclave Expansion of Hydrated Lime	9
Dry Brightness of Pulverized Limestone	12
Dry Screening by Air Jet Sieve	18
Fineness of Pulverized Quicklime and Hydrated Lime by Air Permeability	16
Limestone Grindability	13
Particle Size of Pulverized Limestone	17
Plasticity of Lime Putty	6
Popping and Pitting of Hydrated Lime	10
Residue and Sieve Analysis	15
Settling Rate of Hydrated Lime	14
Slaking Rate of Quicklime	11
Specific Gravity of Hydrated Lime Products	22
Standard Consistency of Lime Putty	5
Water Retention of Hydrated Lime	7
Wet Sieve Analysis of Agricultural Liming Materials	19

1.3 The values stated in SI units are to be regarded as standard. The values given in parentheses are mathematical conversions to inch-pound units that are provided for information only and are not considered standard.

1.4 *This standard does not purport to address all of the safety concerns, if any, associated with its use. It is the responsibility of the user of this standard to establish appro-*

<sup>1</sup> These test methods are under the jurisdiction of ASTM Committee C07 on Lime and are the direct responsibility of Subcommittee C07.06 on Physical Tests. Current edition approved March 1, 2009. Published March 2009. Originally approved in 1934. Last previous edition approved in 2008 as C 110–08a.

<sup>2</sup> For tests on limestone as aggregate, see Vol 04.02 of the *Annual Book of ASTM Standards*. For tests on limestone as building stone, see Vol 04.05 of the *Annual Book of ASTM Standards*.

*priate safety and health practices and determine the applicability of regulatory limitations prior to use.*

## 2. Referenced Documents

### 2.1 ASTM Standards:<sup>3</sup>

- C 28/C 28M Specification for Gypsum Plasters
- C 50 Practice for Sampling, Sample Preparation, Packaging, and Marking of Lime and Limestone Products
- C 51 Terminology Relating to Lime and Limestone (as used by the Industry)
- C 91 Specification for Masonry Cement
- C 109/C 109M Test Method for Compressive Strength of Hydraulic Cement Mortars (Using 2-in. or [50-mm] Cube Specimens)
- C 136 Test Method for Sieve Analysis of Fine and Coarse Aggregates
- C 150 Specification for Portland Cement
- C 185 Test Method for Air Content of Hydraulic Cement Mortar
- C 188 Test Method for Density of Hydraulic Cement
- C 192/C 192M Practice for Making and Curing Concrete Test Specimens in the Laboratory
- C 204 Test Methods for Fineness of Hydraulic Cement by Air-Permeability Apparatus
- C 207 Specification for Hydrated Lime for Masonry Purposes
- C 230/C 230M Specification for Flow Table for Use in Tests of Hydraulic Cement
- C 231 Test Method for Air Content of Freshly Mixed Concrete by the Pressure Method
- C 305 Practice for Mechanical Mixing of Hydraulic Cement Pastes and Mortars of Plastic Consistency
- C 430 Test Method for Fineness of Hydraulic Cement by the 45- $\mu$ m (No. 325) Sieve
- C 472 Test Methods for Physical Testing of Gypsum, Gypsum Plasters and Gypsum Concrete

<sup>3</sup> For referenced ASTM standards, visit the ASTM website, [www.astm.org](http://www.astm.org), or contact ASTM Customer Service at [service@astm.org](mailto:service@astm.org). For *Annual Book of ASTM Standards* volume information, refer to the standard's Document Summary page on the ASTM website.

**\*A Summary of Changes section appears at the end of this standard.**

- C 595 Specification for Blended Hydraulic Cements
- C 670 Practice for Preparing Precision and Bias Statements for Test Methods for Construction Materials
- C 702 Practice for Reducing Samples of Aggregate to Testing Size
- C 778 Specification for Standard Sand
- C 1005 Specification for Reference Masses and Devices for Determining Mass and Volume for Use in the Physical Testing of Hydraulic Cements
- C 1107 Specification for Packaged Dry, Hydraulic-Cement Grout (Nonshrink)
- D 75 Practice for Sampling Aggregates
- E 11 Specification for Wire Cloth and Sieves for Testing Purposes
- E 29 Practice for Using Significant Digits in Test Data to Determine Conformance with Specifications
- E 691 Practice for Conducting an Interlaboratory Study to Determine the Precision of a Test Method

### 3. Terminology

3.1 *Definitions*—Unless otherwise specified, for definitions of terms used in this standard see Terminology C 51.

### 4. General Procedures

4.1 *Sampling*—Samples of lime and limestone for physical analysis shall be taken and prepared in accordance with the requirements of Practice C 50 applicable to the material to be tested.

#### 4.2 Calculation:

4.2.1 The calculations included in the individual procedures sometimes assume that the exact weight specified has been used. Accurately weighed samples which are approximately but not exactly equal to the weight specified may be used provided appropriate corrections are made in the calculation. Unless otherwise stated, weights of all samples and residues should be recorded to the nearest 0.0001 g.

4.2.2 In all mathematical operations on a set of observed values, the equivalent of two more places of figures than in the single observed values shall be retained. For example, if observed values are read or determined to the nearest 0.1 mg, carry numbers to the nearest 0.001 mg in calculation.

4.3 *Rounding Figures*—Rounding of figures to the nearest significant place required in the report should be done after the calculations are completed, in order to keep the final results free from calculation errors. The rounding procedure should follow the principle outlined in Practice E 29.

## PLASTIC PROPERTY TESTING

### 5. Standard Consistency of Lime Putty

#### 5.1 Significance and Use:

5.1.1 In order to measure certain physical properties of a lime putty, such as plasticity, it is necessary to have a uniform or standard consistency (viscosity), since the property measurement is affected by the consistency level.

#### 5.2 Apparatus:

5.2.1 *Modified Vicat Apparatus*—The apparatus, constructed as shown in Fig. 1, shall consist of a bracket, A, bearing a movable brass rod, B, 6.3 mm in diameter and of

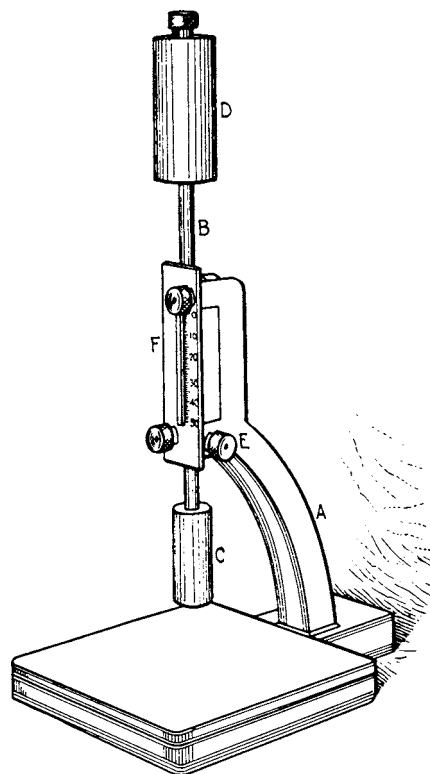

FIG. 1 Modified Vicat Apparatus

suitable length to fit the Vicat bracket. A plunger, C, 12.5 mm in diameter, made of aluminum tubing, shall be attached to the lower end of the rod. The total weight of the rod with plunger shall be 30 g. The lower end of the plunger shall be closed without shoulders or curvature and the tube may be loaded with shot to the specified weight. The total weight required may also be obtained by means of a weight, D, screwed into the rod. The rod can be held in any position by means of a screw, E, and has a mark midway between the ends which moves under a scale, F, graduated in millimetres, attached to the bracket, A.

5.2.2 *Mold*—The conical ring mold shall be made of a noncorroding, nonabsorbent material, and shall have an inside diameter of 70 mm at the base and 60 mm at the top, and a height of 40 mm.

5.2.3 *Base Plate*—The base plate for supporting the ring mold shall be of plate glass and about 100 mm square.

#### 5.2.4 Mechanical Mixers.

#### 5.3 Standard Consistency Determination:

5.3.1 *Mechanical Mixing Procedure Using the Vac-U-Mixer*—To a measured amount of water contained in an 800-cm<sup>3</sup> Vac-U-Mix bowl, add 300 g of hydrated lime and hand mix for 10 s with a stiff spatula (Note 2). Cover putty to prevent evaporation of water. After the applicable soaking period, 30 min maximum for Type S, special hydrated lime, and not less than 16 h nor more than 24 h for Type N, normal hydrated lime, insert the paddle assembly and mix the putty for 30 s with the mechanical mixer. Remove the paddle assembly and scrape down any putty adhering to it and to the sides of the mixing bowl. Remix for 30 s and determine the consistency as prescribed in 5.3. If the penetration is less than 15 mm, return

all of the material to the mixer bowl, add additional water, and remix for 15 s. If the penetration is greater than 25 mm, repeat the test.

**NOTE 2**—Most lime hydrates will require 250 to 300 mL of water to produce a putty of proper consistency for this test if 300 g of lime are used.

**5.3.2 Mechanical Mixing Procedure Using the Hobart N-50 Mixer**—To a measured amount of water contained in the N-50 mixing bowl, add 600 g of hydrated lime and hand mix for 10 s with a stiff spatula (**Note 3**). Cover putty to prevent evaporation of water. After the applicable soaking period, 30 min maximum for Type S, special hydrated lime, and not less than 16 h nor more than 24 h for Type N, normal hydrated lime, insert the paddle assembly and mix the putty for 1 min at a slow speed. Stop the mixer and scrape down the paddle and the sides of the mixing bowl. Remix for 4 min at a slow speed. Determine the consistency as prescribed in **5.3.3**. If the penetration is less than 15 mm, return all of the material to the mixing bowl, add additional water, and remix for 15 s. If the penetration is more than 25 mm, repeat the test.

**NOTE 3**—Most lime hydrates will require 500 to 600 mL of water to produce a putty of proper consistency for this test if 600 g of lime are used.

**5.3.3 Consistency Determination**—To determine consistency, place the mold with its larger end resting on the glass base plate and fill with the lime putty. Then strike off the putty flush with the top of the mold. Center the lime putty, confined in the ring mold resting on the plate, under the rod of the modified Vicat apparatus (**Fig. 1**). Bring the plunger end, C, in contact with the surface of the lime putty and take an initial reading. Release the rod and take the final reading 30 s after the plunger is released. The lime putty is of standard consistency when a penetration of  $20 \pm 5$  mm is obtained. Record both the total amount of water required to bring the putty to standard consistency and the actual penetration. Proceed with the plasticity determination in accordance with **6.3**.

#### 5.4 Precision and Bias:

5.4.1 The precision and bias of this test method has not been determined.

## 6. Plasticity of Lime Putty

### 6.1 Significance and Use:

6.1.1 This test method provides a measure of the degree of stiffening of lime putty of standard consistency as water is withdrawn from it by a standard suction base plate.

6.1.2 Plasticity is an important property when applying mixtures containing lime putty to porous or absorptive surfaces such as in plastering, stuccoing, and masonry construction.

### 6.2 Apparatus:

6.2.1 Determine the plasticity of lime putty using the plasticimeter shown in **Fig. 2**.<sup>4</sup>

6.2.2 **Cleaning and Care of Base Plates**—Base plates may be made of porcelain or plaster. In making the plasticity

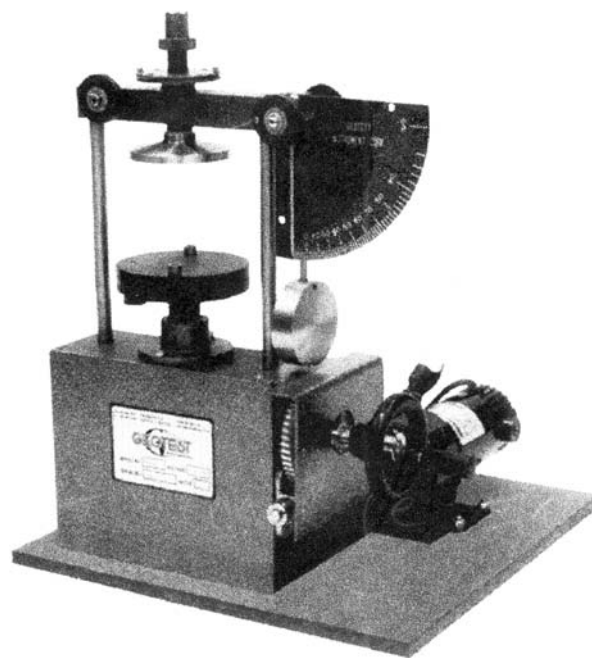

Constants of the Machine:

*Absorption of Porcelain and Plaster Base Plate*—minimum of 40 g in 24 h. For rate of absorption of base plates see **6.2.3.2**.

*Dimension of Base Plate*—25 mm (1 in.) in thickness by 100 mm (4 in.) in diameter.

*Dimensions of Disk*—0.8 to 12.7 mm ( $\frac{1}{32}$  to  $\frac{1}{2}$  in.) in thickness by 76 mm (3 in.) in diameter.

*Speed of Vertical Shaft*—1 revolution in 6 min, 40 s.

*Torque on Disk when Bob Reading is 100*—1.41 N·m.

**FIG. 2 Emley Plasticimeter**

determinations, much of the success attainable depends upon the condition of the base plates. In the case of porcelain plates which are reused, improper cleaning results in clogging of the pores with reduction in the rate of absorption. After a porcelain plate has been used, wipe the excess lime off and immerse the plate in clear water for not less than 2 h, after which transfer it without drying to a dilute solution of hydrochloric acid (HCl, 1 + 9) where it shall be kept immersed for another 2 h. Then transfer to a receptacle containing running water for at least 1 h. The plate is then free of acid. After the removal of excess water, place the plate in an oven overnight at a temperature of between 100 and 110 °C (212 and 230 °F) for drying. Before using, cool the plate to room temperature. In the case of plaster base plates, dry the base plates prior to use in plasticity or absorption testing in an oven at a temperature between 37.8 and 48.9 °C (100 and 120 °F) until they achieve a constant weight. Before using, cool the plaster plate to room temperature in a dessicator charged with a drying agent. If the plate is not to be used immediately after reaching room temperature, continue to store the plate in the dessicator until such time that it is to be used. Plaster base plates shall not be reused after plasticity, total absorption or rate of absorption testing (see **6.2.3**).

### 6.2.3 Absorption of Plasticimeter Base Plates:

6.2.3.1 **Total Absorption**—Plasticimeter base plates when immersed in water at room temperature for a period of 24 h

<sup>4</sup> The sole source of supply of the Emley Plasticimeter known to the committee at this time is Geotest Instrument Corporation, 910 University Place, Evanston, IL 60201, USA. If you are aware of alternative suppliers, please provide this information to ASTM International Headquarters. Your comments will receive careful consideration at a meeting of the responsible technical committee<sup>1</sup>, which you may attend.

shall absorb not less than 40 g of water. Before making the determination, dry the porcelain plates overnight in an oven at a temperature between 100 and 110 °C (212 and 230 °F) and permit to cool to room temperature. Dry the plaster plates in an oven at a temperature between 37.8 and 48.9 °C (100 and 120 °F) until they achieve a constant weight and permit to cool to room temperature in a desiccator charged with a drying agent. After immersion and before weighing either porcelain or plaster plates, wipe off the excess water with a damp cloth.

6.2.3.2 *Rate of Absorption (Note 4)*—When tested over an area 70 mm (2¾ in.) in diameter, the water absorbed by either porcelain or plaster base plates shall be in accordance with the following:

Time, min	Water Absorbed, mL
1	8 to 14
2	5 to 7½
3	4 to 6½
4	4 to 6
5	3½ to 5½

(1) Plaster plates designated for rate of absorption testing shall be statistically representative of all plates manufactured for that purpose and made from one manufacturing batch run. Plaster plates selected for rate of absorption testing may not be re-dried and used for plasticity testing. Porcelain plates designated for rate of absorption testing shall be individually tested and may be re-dried and used for plasticity testing (see 6.2.2).

NOTE 4—A convenient apparatus for determining the rate of absorption consists of a buret sealed onto an inverted glass funnel from which the stem has been removed. The diameter of the larger end of the funnel shall be ground so as to be 70 mm (2¾ in.) in internal diameter. The funnel may be attached to the plate on which the measurement is being made by melted paraffin. The paraffin should not be too hot. A little experience will indicate when it is of the proper consistency. Alternative apparatus manufactured of polycarbonate, metal and other materials are acceptable.<sup>5</sup>

### 6.3 Plasticity Determination:

6.3.1 Lubricate a ring mold such as is described in 5.2.2 with a thin film of water, place on a porcelain base plate (see 6.2.2 and 6.2.3) or a disposable plaster base plate (see 6.2.3), fill with the paste which has been adjusted to standard consistency as described in 5.3.3, and strike off level. Remove the mold by raising it vertically without distorting the paste. Center the base plate and paste in the instrument and turn the

carriage up by hand until the surface of the paste is in contact with the disk and the distance between the disk and the top of the base plate is 32 mm (1¼ in.). Throw the carriage into gear and start the motor. It is essential that the motor be started exactly 120 s after the first portion of the paste has been placed in the mold. Record the time when the first portion of paste is placed in the mold as zero time; the motor is therefore started at 2 min. Take care to protect the specimen from drafts during the test.

6.3.2 Record the scale reading at 1-min intervals until the test is completed. Consider the test complete when: (1) the scale reading reaches 100, (2) any reading is less than the one before, or (3) the scale reading remains constant for three consecutive readings (2 min) and the specimen has visibly ruptured or broken loose from the base plate. Note the time and the scale reading at the end of the test.

### 6.4 Calculation:

6.4.1 Calculate the plasticity figure as follows:

$$P = \sqrt{F^2 + (10T)^2} \quad (1)$$

where

$P$  = plasticity figure,

$F$  = scale reading at the end of the test, and

$T$  = time in minutes from the time when the first portion of paste was put in the mold to the end of the test.

### 6.5 Precision and Bias:

6.5.1 The precision of this test method is based on interlaboratory studies conducted in March and October of 2007. To determine interlaboratory and intralaboratory precision, one operator from each of ten different laboratories tested three different dolomitic Type S hydrated lime samples and one dolomitic Type N hydrated lime sample made into lime putty of standard consistency for Final Vicat Penetration (mm) and Calculated Plasticity Figure (Emley Units). Each laboratory obtained three replicate test results for each of the supplied materials.<sup>6</sup> Statistical summaries of the testing results are shown in Tables 1 and 2.

6.5.1.1 *Repeatability*—Two test results obtained within one laboratory shall be judged not equivalent if they differ by more than the “r” value for that material; “r” is the interval representing the critical difference between two test results for the same material, obtained by the same operator using the same equipment on the same day in the same laboratory.

<sup>5</sup> Godbey, Richard J. and Thomson, Margaret L., “Standardized Laboratory Apparatus for Measuring Emley Baseplate Rate of Absorption,” Rochell Jaffe, Ed., Proceedings: 2005–International Building Lime Symposium, Michael Tate, Chairperson, National Lime Association, Arlington, VA, ISBN 0-9767621-0-2.

<sup>6</sup> Supporting data have been filed at ASTM International Headquarters and may be obtained by requesting Research Report RR: C07–1005.

**TABLE 1 Final Vicat Penetration (mm)**

MATERIAL	Average <b>Xbar</b>	Repeatability Standard Deviation <b>sr</b>	Reproducibility Standard Deviation <b>sR</b>	Repeatability Limit <b>r</b>	Reproducibility Limit <b>R</b>
Type S Hydrated Lime Samples A, C, F	19.7	2.76	2.81	7.7	7.9
Type S Hydrated Lime Samples B, E, G	18.4	2.13	2.53	5.9	7.1
Type S Hydrated Lime Samples D H I	18.4	2.83	2.83	7.9	7.9
Type N Hydrated Lime	17.8	2.59	2.59	7.3	7.3



**TABLE 2 Calculated Plasticity Figure (Emley Units)**

MATERIAL	Average	Repeatability Standard Deviation	Reproducibility Standard Deviation	Repeatability Limit	Reproducibility Limit
	<b>Xbar</b>	<b>sr</b>	<b>sR</b>	<b>r</b>	<b>R</b>
Type S Hydrated Lime Samples A, C, F	502	22.70	41.62	64	117
Type S Hydrated Lime Samples B, E, G	480	42.93	66.77	120	187
Type S Hydrated Lime Samples D H I	381	40.52	49.11	114	138
Type N Hydrated Lime	438	25.06	53.51	70	150

6.5.1.2 *Reproducibility*—Two test results should be judged not equivalent if they differ by more than the “R” value for that material; “R” is the interval representing the difference between two test results for the same material, obtained by different operators using different equipment in different laboratories.

6.5.1.3 Any judgment in accordance with statements 6.5.1.1 or 6.5.1.2 would have an approximate 95 % probability of being correct. To judge the equivalency of two test results, it is recommended to choose the material closest in characteristics to the test material (Type S or Type N hydrated lime).

6.5.2 *Bias*—At the time of the studies, there was no accepted reference material suitable for determining the bias for this test method, therefore no statement on bias can be made. To judge the equivalency of two test results, it is recommended to choose the material closest in characteristics to the test material (Type S or Type N hydrated lime).

## 7. Water Retention of Hydrated Lime

### 7.1 Significance and Use:

7.1.1 This test method measures the ability of the hydrated lime in a plastic mix with sand to retain water, and hence retain consistency of the mix, when subjected to an applied suction. This ability, measured as a percent of the original consistency, is indicative of the workability to be expected in a masonry mortar containing the lime.

### 7.2 Proportioning and Mixing:

7.2.1 *Apparatus*—The apparatus used shall conform to Practice C 305.

7.2.2 *Proportions*—The mortar tested shall be composed of 500 g of lime and 1500 g of standard sand conforming to 8.2.3. If hydrated lime putty is used, use that weight of putty that is equivalent to 500 g of dry hydrated lime.

### 7.2.3 Mechanical Mixing:

7.2.3.1 Place the dry paddle and the dry bowl in the mixing position in the mixer.

7.2.3.2 Place a measured quantity of water in the bowl.

7.2.3.3 Add the lime to the water, then start the mixer and mix at slow speed ( $140 \pm 5$  r/min) for 30 s.

7.2.4 Add the entire quantity of sand slowly over a 30-s period while mixing at slow speed.

7.2.5 Stop the mixer, change to medium speed ( $285 \pm 10$  rpm) and mix for 30 s.

7.2.6 Stop the mixer and let the mortar stand for 1½ min. (During the first 15 s of this interval, quickly scrape down into

the batch any mortar that may have collected on the side of the bowl, then for the remainder of this interval cover the bowl with the lid.)

7.2.7 Finish the mixing for 1 min at medium speed.

7.2.8 In any case requiring a remixing interval, any mortar adhering to the side of the bowl shall be quickly scraped down into the batch prior to remixing.

### 7.3 Consistency:

7.3.1 *Apparatus*—The flow table and mold used for the measurement of consistency of the mortar shall conform to Specification C 230/C 230M.

7.3.2 *Procedure*—Carefully wipe dry the flow table top and place the flow mold at the center. Immediately after completing the mixing operation, fill the mold with mortar gently pressed into place by the finger tips to ensure uniform filling free of voids. Smooth off the mortar level with the top of the mold by aid of a trowel, and remove the mold. Immediately drop the table through a height of 13 mm (½ in.), 25 times in 15 s. The flow is the resulting increase in diameter of the mortar mass, expressed as the percentage of the original diameter. The mortar may be adjusted, if the flow is below 100 %, by additions of water until the flow is within the range from 100 to 115 %. Make each adjustment by returning the mortar to the original mixing bowl, add water, and then mix at medium speed ( $285 \pm 10$  r/min) for 30 s. If the flow of the original mortar is greater than 115 %, prepare a new batch.

### 7.4 Water Retention Test:

7.4.1 *Apparatus*—The equipment shall conform to the apparatus used for the water retention test in Specification C 91 (see Fig. 3).

### 7.4.2 Procedure:

7.4.2.1 Adjust the vacuum regulator to maintain a vacuum of  $51 \pm 3$  mm as measured on the vacuum gauge. Seat the perforated dish on the greased gasket of the funnel. Place a wetted filter paper in the bottom of the dish. Turn the stopcock to apply the vacuum to the funnel and check the apparatus for leaks and to determine that the required vacuum is obtained. Then turn the stopcock to shut off the vacuum from the funnel.

7.4.2.2 Immediately after the final consistency test (7.3.2), return all of the mortar to the bowl and remix the entire batch for 15 s at medium speed. Immediately after remixing the mortar, fill the perforated dish with the mortar to slightly above the rim. Tamp the mortar 15 times with the tamper. Apply ten of the tamping strokes at approximately uniform spacing adjacent to the rim of the dish and with the long axis of the tamping face held at right angles, to the radius of the dish.

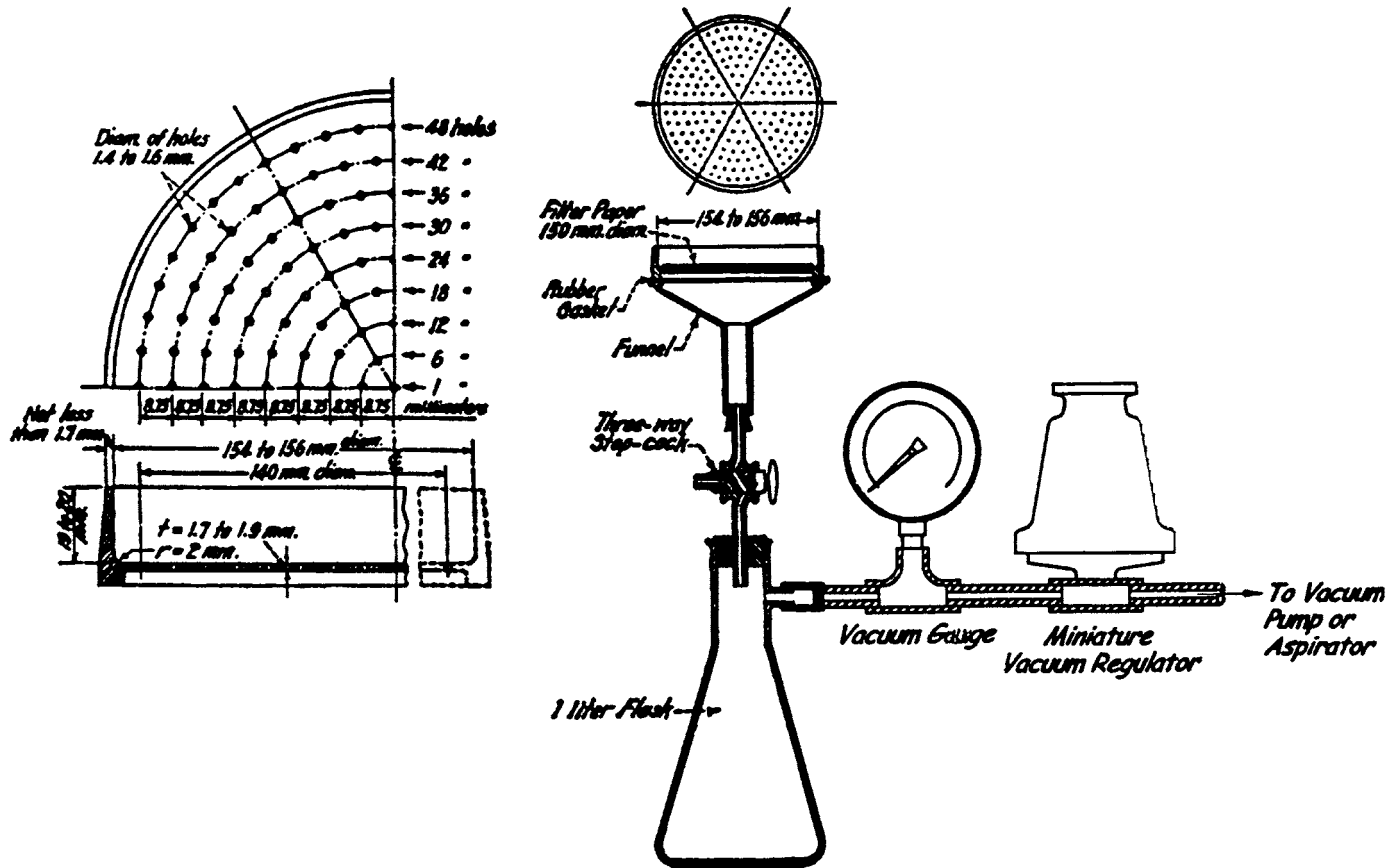

FIG. 3 Vacuum Gauge Apparatus Assembly for the Water Retention Test

Apply the remaining five tamping strokes at random points distributed over the central area of the dish. The tamping pressure shall be just sufficient to ensure filling of the dish. On completion of the tamping, the top of the mortar should extend slightly above the rim of the dish. Smooth off the mortar by drawing the flat side of the straightedge (with the leading edge slightly raised) across the top of the dish. Then cut off the mortar to a plane surface flush with the rim of the dish by drawing the straightedge with a sawing motion across the top of the dish in two cutting strokes, starting each cut near the center of the dish. If the mortar is pulled away from the side of the dish during the process of cutting off the excess mortar, gently press the mortar back into contact with the side of the dish using the tamper.

7.4.2.3 Turn the stopcock to apply vacuum to the funnel. After suction for 60 s, quickly turn the stopcock to expose the funnel to atmospheric pressure. Immediately slide the perforated dish off the funnel, touch it momentarily on a damp cloth to remove droplets of water, and set the dish on the table. Then using the bowl scraper (rubber scraper as specified in Practice C 305), plow and mix the mortar in the dish for 15 s. Upon completion of mixing, place the mortar in the flow mold and determine the flow. Carry out the entire operation without interruption and as quickly as possible. Not more than 30 min should be required for completion, starting from the completion of the mixing of the mortar for the first flow determination.

#### 7.4.3 Calculation:

7.4.3.1 Calculate the water retention value for the mortar as follows:

$$\text{Water retention value} = (A/B) \times 100 \quad (2)$$

where:

*A* = flow after suction, and

*B* = flow immediately after mixing.

#### 7.5 Precision and Bias:

7.5.1 No precision data are available due to the limited use of this test method. Therefore, users are advised to develop their own laboratory precision.

## 8. Air Entrainment

### 8.1 Significance and Use:

8.1.1 Hydrated lime, particularly that containing an air-entraining additive, used in masonry mortar may contribute to the air content of the mortar. Certain specifications and applications of mortar place a limit on this air content.

### 8.2 Apparatus:

8.2.1 *Flow Table*, conforming to the requirements prescribed in Specification C 230/C 230M.

8.2.2 *Mixing Apparatus*, conforming to the requirements as prescribed in Practice C 305.

8.2.3 The sand shall be a blend of equal parts by weight of graded Ottawa sand and standard 20-30 Ottawa sand. The fineness of graded Ottawa sand and standard 20-30 sand may be checked by using the methods described in Specification C 778.

### 8.3 Preparation of Mortar:

8.3.1 *Proportions for Mortar*—Lime-based mortars for measurement of air entrainment shall be proportioned to conform, in batch size, to the unit weights by volume of

cementitious material and aggregate as shown in Table 3. The cement shall conform to Specifications C 150, C 595, or C 1107, and the hydrated lime to Specification C 207. The quantity of water, measured in millilitres, shall be such as to produce a flow of  $110 \pm 5\%$  as determined by the flow table. Proportions for the generally used batch sizes based on Table 4 material unit weight shall contain the weights as prescribed in Table 5.

8.3.2 *Mixing of Mortars*—Mix the mortar in accordance with the procedure for mixing pastes in Practice C 305.

8.3.3 *Determination of Flow*—Determine the flow in accordance with the Procedure section of Test Method C 109/C 109M.

### 8.4 Procedure:

8.4.1 If the mortar has the correct flow, use a separate portion of the mortar for the determination of entrained air. The amount of air entrainment shall be determined by one of two methods. The density method determines air content from the measured density of the mortar, the known density of constituents, and the mixture properties. The air pail method measures air content using Test Method C 231.

#### 8.4.2 Density Method:

##### 8.4.2.1 Apparatus:

*Scales, Sieves, Glass Graduates, Tamper, Measure, Straightedge, Spatula, Tapping Stick, and Spoon*, conforming to the requirements given in Test Method C 185.

##### 8.4.2.2 Procedure:

(1) Fill a 400 ml measure with the mortar sample in accordance with Test Method C 185.

(2) Determine the weight of mortar in the measure.

##### 8.4.2.3 Calculation:

Calculate the air content of the mortar and report it to the nearest 0.1 % as follows:

$$D = (W_1 + W_2 + W_3 + V_w) / [(W_1/S_1) + (W_2/S_2) + (W_3/S_3) + V_w] A \\ = 100 - (W_m/4D) \quad (3)$$

where:

*D* = density of air-free mortar,

*W*<sub>1</sub> = weight of cement, g,

*W*<sub>2</sub> = weight of lime, g,

*W*<sub>3</sub> = weight of blended Ottawa sand, g,

*V*<sub>w</sub> = water used, mL,

*S*<sub>1</sub> = specific gravity of portland cement,

*S*<sub>2</sub> = specific gravity of hydrated lime,

*S*<sub>3</sub> = specific gravity of blended Ottawa sand,

*A* = volume % of entrained air, and

*W*<sub>m</sub> = weight of 400 mL of mortar, g.

**TABLE 3 Unit Weights and Apparent Specific Gravities**

Materials	Unit weight, kg/m <sup>3</sup> (lb/ft <sup>3</sup> ) <sup>A</sup>	Specific Gravity
Portland Cement	1,504 (94)	3.15
Blended Cement	obtain from purchaser	
Hydraulic Cement	obtain from purchaser	
Hydrated Lime	640 (40)	2.30
Blended Ottawa Silica Sand	1,280 (80)	2.65

<sup>A</sup> The unit weight values listed for cementitious materials are assumed values commonly used in construction practice.

**TABLE 4 Precision Data**

Material	Labs	Results in °C Rise		<i>r</i>	<i>R</i>
		Time	Range Tested		
High Calcium	12	30 s	12.3–44.4	1.56	4.21
High Calcium	11	3 min	32.1–56.1	1.72	4.72
Dolomitic	10	30 s	3.6–12.0	1.38	2.84
Dolomitic	9	3 min	21.2–36.4	1.62	3.72

**TABLE 5 Weight of Materials for Mortar Batch**

Mortar Type	Proportions by Volume	Portland Cement (g)	Hydrated Lime (g)	Blended Ottawa Silica Sand (g)
M	1:¼ :3¾	470.0	62.5	1,500
S	1:½ :4½	376.0	100.0	1,440
N	1:1:6	282.0	150.0	1,440
O	1:2:9	188.0	200.0	1,440
Lime/Sand	1:3		300.0	1,440

NOTE 5—For lime/sand mortars,  $W_1$  and  $S_1$  should be dropped from the calculation.

#### 8.4.2.4 Precision and Bias:

(1) The single operator within laboratory standard deviation has been found to be 0.56 % air content throughout the range of 8 % to 19 % air content. Therefore results of two properly conducted tests by the same operator on similar batches of mortar should not differ by more than 1.6 % air content.

(2) The multilaboratory standard deviation has been found to be 1.0 % air content throughout the range of 8 % to 19 % air content. Therefore, results of two different laboratories on similar batches of mortar should not differ from each other by more than 2.8 % air content (see Test Method C 185).

#### 8.4.3 Air Pail Method

##### 8.4.3.1 Apparatus:

(1) *Air Meters*—There are two basic operational designs employing the principle of Boyle’s law. Both types of units are detailed in Test Method C 231.

(2) *Calibration Vessel, Spray Tube, Tamping Rod, Mallet, Strike-Off Bar, Funnel, and Water Measure*, conforming to the requirements given in Test Method C 231.

##### 8.4.3.2 Procedure:

(1) Calibrate the air meter using procedures described in Test Method C 231 Section 5.

(2) Fill the air meter and determine air content by using the method detailed in Test Method C 231 Section 8, except that for Type B meters with a volume of 1 L or less, there shall be no use of an internal vibrator as required in Test Method C 231 and described in Practice C 192.

(3) When using Type B meters with a volume of 1 L or less, compact the mortar into the bowl by tamping the mortar 15 times with a tamper meeting the requirements of Test Method C 185 Section 5. Apply 10 of the tamping strokes near the outside circumference of the mortar bowl evenly spaced at right angles to the radius of the bowl and five of the tamping strokes at random points distributed in the center of the bowl. Apply the tamping strokes in such a manner as to only settle and consolidate the mortar into the bowl without the addition of voids left by the insertion and removal of the tamper at each stroke.

#### 8.4.3.3 Precision and Bias:

Although precision for the test method for air content of freshly mixed concrete has been reported in Test Method C 231, the precision of this test method has not been determined for lime-based mortars. When sufficient data has been obtained and analyzed, a statement of precision will be provided. In the meantime users of the test method are advised to develop their own.

## SOUNDNESS TESTING

### 9. Autoclave Expansion of Hydrated Lime

#### 9.1 Significance and Use:

9.1.1 Expansion of pressed tablets of hydrated lime generally indicates the presence of unhydrated oxides of magnesium and calcium. The relation of the degree of expansion in this test method to field performance has not been determined.

#### 9.2 Apparatus:

9.2.1 *Mold and Press*—A steel mold capable of producing a press tablet at least 0.032 m (1.25 in.) in diameter and 0.006 m (0.25 in.) thick, and able to sustain at least 88.9 kN (20 000 lbf) pressure from a suitable press. It should be provided with a release jig also.

9.2.2 *Autoclave*, capable of holding 1034 kPa (150 psi) for 2 h.

9.2.3 *Micrometer*, dial-type, capable of measuring 2.54 μm (0.0001 in.).

9.2.4 *Microscope*, with graduated lens for measuring 0.10 mm.

#### 9.3 Procedure:

9.3.1 Weigh out 15 g of hydrated sample, place in the mold, and press into a tablet. Press to 33.4 kN (7500 lbf) for 10 s, then increase pressure to 88.9 kN (20 000 lbf) or more. Hold for 10 s before releasing. Press tablet from mold with jig and draw three diameter lines across the surface of the tablet using a lead pencil. Draw two diameter lines normal to each other and draw the third bisecting the 90° angles of the other two. Measure the diameters with a dial micrometer and place the tablet on the autoclave rack. Use aluminum foil to protect the tablets from water dripping. Autoclave at 862 to 1034 kPa (125 to 150 psi) for 2 h. Begin timing when the pressure reaches 345 kPa (50 psi). After the autoclaving interval, allow the autoclave to cool, remove the tablet, and remeasure the diameters. Calculate the average percent expansion of the tablet from the before and after measurements.

#### 9.4 Expansion of Hydrated Lime-Portland Cement-Aggregate:

##### 9.4.1 Materials:

9.4.1.1 *Standard Cement*—Type I or Type II portland cement.

9.4.1.2 *Standard Aggregate*—Pulverized limestone, minus 212-μm (No. 70) sieve, having less than 0.5 % silicon dioxide (SiO<sub>2</sub>).

##### 9.4.2 Procedure:

9.4.2.1 *Test Tablet*—Make up a pressed tablet in accordance with the procedure outlined in 9.3.1 using the following mixture for the sample:

Standard portland cement	14 g
Hydrated lime	8 g



Standard aggregate (pulverized limestone) 72 g

Blend the mix until homogeneous.

9.4.2.2 *Standard Tablet*—Make up a pressed tablet in accordance with the procedure outlined in 9.3.1 using the following mixture for the sample:

Standard portland cement 7 g  
Standard aggregate (pulverized limestone) 16 g

Blend the mix until homogeneous.

9.4.2.3 Autoclave and calculate expansions of the test tablet and the standard tablet in accordance with 9.3.1.

9.4.2.4 Determine the autoclave expansion of hydrated lime for masonry purposes by subtracting the average percent expansion of the standard tablet from the sample tablet.

#### 9.5 Precision and Bias:

9.5.1 No precision data are available due to the limited use of this test method. Therefore, users are advised to develop their own laboratory precision. No statement is being made about the bias of this test method.

### 10. Popping and Pitting of Hydrated Lime

#### 10.1 Significance and Use:

10.1.1 Pops and pits are caused by the hydration and expansion of coarse particles of unhydrated lime or lime-impurity reaction products present in the hydrated lime. The level of popping and pitting in the sample is indicative of the potential for the appearance of surface defects in plastering applications.

#### 10.2 Gauging Plaster:

10.2.1 The gauging plaster used for the popping and pitting test shall conform to the Test Methods section of Specification C 28/C 28M and shall have a setting time of not more than 1 h when tested in accordance with Test Methods C 472. Test the gauging plaster without lime in the manner described in 10.3 to ensure its freedom from pops and pits. If any pops or pits are found, provide another lot of gauging plaster that is free of pops and pits when subjected to this test.

#### 10.3 Procedure:

10.3.1 Mix 100 g of hydrated lime with sufficient water to bring to such a consistency as to give a penetration of  $20 \pm 5$  mm when tested in accordance with 5.3.3. Mix into this putty, 25 g of gauging plaster (10.2.1), adding more water as required to maintain workable consistency. Spread on a glass plate to make a pat at least 150 by 200 mm (6 by 8 in.) by approximately 3 mm ( $\frac{1}{8}$  in.) in thickness. Trowel to a smooth finish. Allow to stand overnight.

10.3.2 Place the specimen and plate on a rack in the steam bath so that water is not in contact with the specimen to be tested. Provide a sloping cover above the specimen to prevent condensed steam from dripping onto the surface of the specimen. Raise the temperature of the water in the steam bath to boiling and maintain at boiling for 5 h. Remove the specimens from the bath and examine for pops and pits.

10.3.3 The pitting potential of hydrated lime can be determined in conjunction with autoclave expansion as in 9.3.1. However, it is not necessary to measure diameter, if only the pitting potential is to be determined. After following the

procedure for expansion in 9.3.1, examine the pressed tablet under the measuring microscope, and count and measure the pits in millimetres.

## APPLICATION TESTING

### 11. Slaking Rate of Quicklime

#### 11.1 Significance and Use:

11.1.1 The temperature rise in 30 s is a measure of the reactivity of the softer-burned portion of the quicklime. Total slaking time provides a measure of the overall degree of reactivity of the material. Total temperature rise is largely dependent on the available lime content of the sample.

11.1.2 These slaking parameters provide an indication of the performance of the quicklime to be expected in industrial slaking systems. Slaking characteristics have an effect on lime slurry properties such as settling characteristics, viscosity, particle size, and reaction rate.

#### 11.2 Apparatus:

11.2.1 *Mechanical Stirrer*, speed  $400 \pm 50$  r/min, fitted with a special stirring rod.

11.2.2 *Modified Dewar Flask*, 665-mL, fitted with special rubber gasket covers.

11.2.3 *Thermometer*, dial-type, 0 to 100 °C range in 1 °C increments or thermocouple with a response time equivalent to or faster than the dial thermometer.

#### 11.2.4 Torsion Balance.

11.2.5 *Sieve*, 203-mm (8-in.), 3.35-mm (No. 6), conforming to Specification E 11.

11.2.6 An apparatus essentially the same as that illustrated in Fig. 4 and Fig. 5 shall be used. The apparatus consists of a covered reaction container fitted with a mechanical stirrer and thermometer. The quicklime charge shall be stirred with a mechanical stirrer fitted with a stainless steel rod, the end of which is formed into a loop to follow the contour of the reaction container. The vacuum reaction flask shall be provided with a cover consisting of two circular pieces of gasket rubber sheet, approximately 3 mm ( $\frac{1}{8}$  in.) thick. The first piece is provided with a single radial slot that slides over the stirring rod and the thermometer. The second piece (top) has a similar slot plus a hole to provide for the dial thermometer. When the two cover pieces are in place, the slot on the lower piece is at right angles to the slot on the upper piece with the thermometer stem extending through the lower slot. The apparatus may be assembled by any convenient supporting equipment.

#### 11.3 Procedure:

11.3.1 Prepare the sample of quicklime (as rapidly as possible to prevent sample deterioration) so that a majority of the material passes a 3.35 mm (No. 6) sieve. Place the sample in an airtight container and allow to come to room temperature before testing. The slaking rate of lime is significantly affected by the particle size of the sample and must be as close to a 3.35 mm (No. 6) sieve as possible. It is not necessary that 100 % of the sample pass a 3.35 mm (No. 6) sieve, but all of the sample, including the plus 3.35 mm (plus No. 6) fraction, must be used in the test.

11.3.2 *Slaking Rate*—Adjust the temperature of about 500 mL of distilled water in accordance with the schedule given in Table 6, and add the specified amount to the Dewar flask. Set

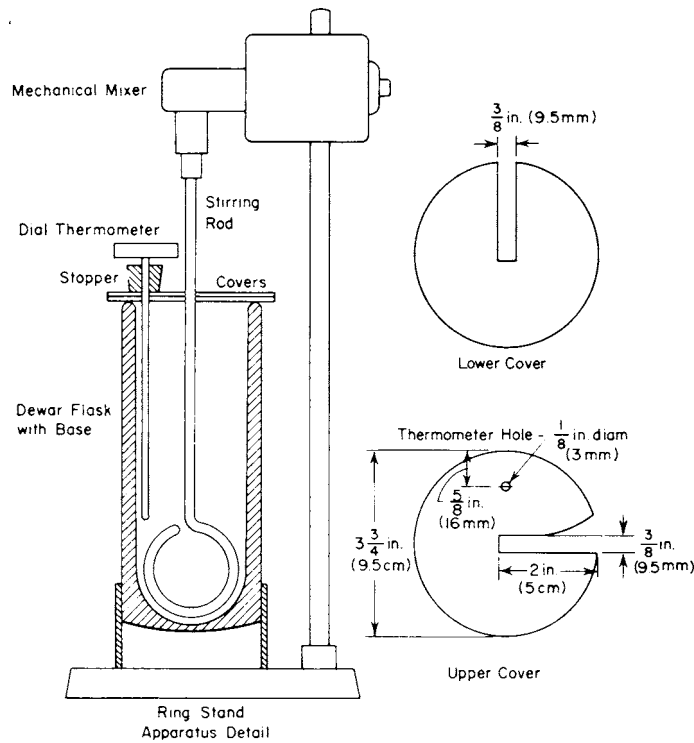

FIG. 4 Slaking Reactivity Apparatus

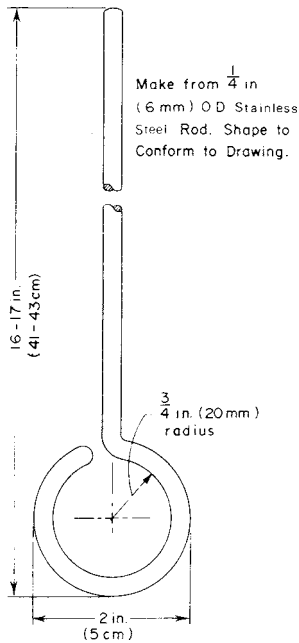

FIG. 5 Stirring Rod Detail

the agitator revolving at  $400 \pm 50$  r/min. The temperature of the water in the flask must be  $\pm 0.5$  °C of the desired temperature. Quarter and weigh out the required amount of the prepared quicklime sample. Add the quicklime to the water without delay and simultaneously begin timing. Put the covers in place immediately. Take a reading at each 30 s interval.

11.3.3 Continue readings until less than 0.5 °C temperature change is noted in each of three consecutive readings. The total active slaking time will then be the time at which the first of the

TABLE 6 Schedule for Slaking Rate

	Material to Be Tested	
	Dolomitic	High Calcium
Temperature of water, °C	40	25 <sup>A</sup>
Quantity of water, mL	400	400
Quantity of quicklime, g	120	100

<sup>A</sup> Initial temperature of 40 °C may be used, provided the report of results states the initial temperature.

three consecutive readings was taken. The temperature at this time will be considered the final reaction temperature. Subtract the initial temperature from the final temperature to obtain the total temperature rise. Subtract the initial temperature from the temperature at 30 s for the temperature rise in 30 s. Subtract the initial temperature from the temperature at 3 min for the temperature rise in 3 min.

11.3.4 *Residue of Quicklime*—Allow slurry from the slaking/reactivity test to continue slaking for a minimum of 15 min. Stop the stirrer and remove the Dewar flask, washing the slurry residue from the stirring rod into the flask. Carefully and slowly pour the residue through a No. 30 (600- $\mu$ m) sieve (**Note 6**). Wash the slurry through the screen with a spray of tap water, being careful not to lose any residue over the top of the sieve. Continue washing until all slurry is through the sieve and all that remains are residue particles. Blot dry the bottom of the sieve with a paper towel and then place in a drying oven for 1 h at  $105 \pm 5$  °C. Remove from the oven, cool, collect the dried residue, and weigh.

$$\text{Calculation: } \frac{\text{Grams of Residue}}{\text{Weight of Sample}} \times 100 = \% \text{ Residue}$$

NOTE 6—The quicklime being slaked is very hot and highly basic. Caution must be taken not to let this material contact the eyes or skin as this may cause severe thermal and/or chemical burns.

#### 11.4 Report:

11.4.1 Record the actual temperature rise and plot a suitable curve showing temperature rise as the ordinate and time as the abscissa. The results may also be reported as:

11.4.1.1 Temperature rise in 30 s (or at any other designated time) in degrees Celsius,

11.4.1.2 Total temperature rise in degrees Celsius, and

11.4.1.3 Total active slaking time in minutes.

#### 11.5 Precision and Bias:

11.5.1 Twelve laboratories cooperated in the testing of five high calcium quicklimes and four dolomitic quicklimes thereby obtaining the repeatability ( $r$ ) and reproducibility ( $R$ ) (Practice E 691) data contained in Table 4.<sup>7</sup>

11.5.2 Due to the lack of a recognized industry standard, the bias of this test method has not been determined. The variety of reporting options also complicates obtaining a suitable bias statement.

## 12. Dry Brightness of Pulverized Limestone

### 12.1 Summary of Test Method:

12.1.1 A sample of the dry material is compressed and its reflectance measured on a reflectometer that has previously been standardized.

### 12.2 Significance and Use:

12.2.1 This test method provides a measure of the reflectance, or whiteness, or both of ground calcium carbonate products by comparison with a standard, using green and blue filters.

### 12.3 Apparatus:

#### 12.3.1 Reflectometer:

12.3.2 *Dry Powder Press* (See Fig. 6)—Instructions, as supplied by the manufacturer, for preparation of the sample and use of the powder press shall be explicitly followed.

12.3.3 *White Porcelain Standard Plaque*, to be used as secondary standard.

### 12.4 Reagent:

12.4.1 *Barium Sulfate* ( $BaSO_4$ )—Use Eastman Kodak<sup>8</sup> Chemical No. 6091<sup>9</sup>, white reflectance standard only.

### 12.5 Calibration and Standardization:

12.5.1 *Zero Scale Calibration* (bottom of scale standardization):

12.5.1.1 Place the black glass provided with the instrument over the specimen port, so that the shiny side is towards the opening. The glass should be positioned so that no light escapes from the black glass-opening interface.

12.5.1.2 The processor is then adjusted to read zero reflectance.

12.5.2 *Standardizing of the White Standard* (standardization of the upper part of the scale):

12.5.2.1 A primary standard pellet (barium sulfate) which is free from surface flaws should be positioned over the specimen port so that no light can escape at the pellet-opening interface.

12.5.2.2 The Eastman Kodak barium sulfate reflectance standard is provided with reflectance values at various wavelengths. Since some variation is possible between lots of  $BaSO_4$ , the values used to standardize the reflectometer must be calculated. A normal  $Y$  value will be between 99.0 and 98.5, depending on the lot number.

12.5.2.3 After this has been accomplished, a reading of the white standard plaque can be taken and the values of  $X$ ,  $Y$ , and  $Z$  recorded. This plaque can then be used as a secondary standard for future standardizations. This reduces the necessity of making a barium sulfate pellet for every test series.

### 12.6 Procedure:

12.6.1 The reflectometer must be given ample warm-up time prior to the sample readings.

12.6.2 The reflectometer must first be standardized; this consists of standardization of the bottom of the scale and standardization of the upper part of the scale.

12.6.3 Sample pellets should then be pressed (Note 7) following manufacturer instructions explicitly (Note 8).

NOTE 7—Ground products with more than 0.5 % residue on a 45- $\mu$ m (No. 325) screen will require special care in preparing the sample cup. The coarser the product, the harder to obtain a compact, smooth surface.

NOTE 8—Some reflectometers and spectrophotometers can measure reflectance with the powder sample in a horizontal position, thus eliminating the necessity to prepare a sample pellet. Also, coated ground limestones are difficult to pelletize. Loose powder samples should be smoothed in a convenient sized container until the surface is level and free from cracks and other surface defects.

12.6.4 After the reflectometer has been standardized, the sample pellets are centered beneath the opening and positioned so that no light escapes from the pellet-opening interface.

12.6.5 The samples are then read for  $X$ ,  $Y$ ,  $Z$ ,  $L$ ,  $a$ , and  $b$  values. These values are recorded.

12.6.6 To determine if the values of the reflectometer have drifted, the white standard (either the barium sulfate pellet or the porcelain plaque) is placed over the specimen port and read. Values should be the same as those placed in the processor during the standardization procedure.

### 12.7 Report:

12.7.1 The  $Y$  value is recorded as the dry brightness of that specific limestone.

### 12.8 Precision and Bias:

12.8.1 The same instrument, operator, and standard should reproduce  $\pm 0.2$  %. Different instrument (Note 9), operators, and standard should agree  $\pm 1.0$  %.

NOTE 9—It is recognized that there are various manufacturers of reflectometers, and testing has been undertaken to relate  $X$ ,  $Y$ , and  $Z$  tristimulus color values from one instrument to another. If results of this comparison testing are desired, please contact the Pulverized Limestone Association.

## 13. Limestone Grindability Determination by the Laboratory Ball Mill Method

### 13.1 Scope:

<sup>7</sup> Supporting data have been filed at ASTM International Headquarters and may be obtained by requesting Research Report RR: C07-1003.

<sup>8</sup> Registered trademark.

<sup>9</sup> The sole source of supply of the apparatus known to the committee at this time is Eastman Kodak Co., 343 State St., Rochester, NY 14650. If you are aware of alternative suppliers, please provide this information to ASTM International Headquarters. Your comments will receive careful consideration at a meeting of the responsible technical committee,<sup>1</sup> which you may attend.



FIG. 6 Dry-Powder Press

13.1.1 This test method is used to determine the relative grindability or ease of pulverization of limestones of differing hardness and to report this as a grindability index.

13.1.2 This test method is applicable to all types of limestone.

#### 13.2 Summary of Test Method:

13.2.1 Limestone of a specified size range is wet ground in a ball mill therein receiving a specified amount of grinding energy. The amount of minus 75- $\mu\text{m}$  (200-mesh) limestone produced is measured by wet sieving and reported as the percent passing 75- $\mu\text{m}$  (200-mesh) after 5000 revolutions. This is the grindability index.

#### 13.3 Significance and Use:

13.3.1 This test method is useful for comparison and acceptance testing of limestone for applications where fine ground limestone is desired.

#### 13.4 Apparatus:

13.4.1 *Jar Mill*, operated at  $110 \pm 10$  r/min.

13.4.2 *Mill Jar*, ceramic 14 cm (5½ in.) diameter by 20.2 cm (6¾ in.) high.

13.4.3 *Grinding Media*, 160  $\pm$  1 g total, consisting of seven ceramic 21 by 21 mm (13/16 by 13/16 in.) cylindrical grinding media (about 23 g each).

13.4.4 The sieves used shall conform to the requirements of Specification E 11.

13.4.5 Weights and weighing devices, shall conform to the requirements of Specification C 1005.

13.4.6 *Drying Oven*, capable of maintaining 100 °C.

13.4.7 *A Chipmunk Crusher*, capable of breaking large rocks to less than 6.35 mm (¼ in.).

13.4.8 *Riffle Sample Splitter*, open pan, 12.7 mm (½ in.) chute width.

13.4.9 *Stopwatch*.

#### 13.5 Reagents and Materials:

13.5.1 *Milling Solution*, a 0.1 % solution of acrylate based dispersant. The dispersant chosen should not increase the solubility of limestone in water.<sup>10</sup>

#### 13.6 Sampling:

13.6.1 Sample in accordance with Practice D 75.

13.6.2 Reduce the sample in accordance with Practice C 702 and prepare by sieving out the material that passes a 850- $\mu\text{m}$  (No. 20) sieve<sup>11</sup> and is retained on a 425- $\mu\text{m}$  (No. 40) sieve.<sup>11</sup>

#### 13.7 Procedure:

13.7.1 Weigh seven grinding media, make adjustments (by substitutions or filing) to bring total weight to 160 g  $\pm$  1 g.

13.7.2 If the jar mill has provision for automatic shut-off, set it for 5000 revolutions, otherwise determine the mill r/min by counting the revolutions in an accurately timed period (using stopwatch) and then calculate the exact time required for 5000 revolutions.

13.7.3 Weigh out  $20 \pm 0.01$  g of dried 20 by 40 mesh limestone. Record actual weight as  $W_1$ .

13.7.4 Add 180 mL of milling solution to clean and empty mill jar.

13.7.5 Add the seven grinding media and quantitatively transfer the limestone sample to the mill jar and secure the top.

13.7.6 Place the mill jar on the mill rollers and operate the mill for the exact time required to make 5000 revolutions.

13.7.7 Quantitatively transfer the limestone slurry from the jar mill by rinsing the entire contents onto a coarse sieve (for example, 3.35 mm (No. 6)) and an underlying 75- $\mu\text{m}$  (No. 200) sieve. Rinse the media and coarse sieve and separate the sieves.

13.7.8 Wet sieve the sample remaining on the 75- $\mu\text{m}$  (No. 200) sieve to remove the finer material.

13.7.9 Dry and weigh the residue from the 75- $\mu\text{m}$  (No. 200) sieve and record as  $W_2$  (to the nearest 0.01 g).

#### 13.8 Calculation:

13.8.1 Calculate the grindability index ( $GI$ ) as follows:

$$GI = (W_1 - W_2)/W_1 \times 100 \quad (4)$$

#### 13.9 Precision and Bias:

13.9.1 The precision and bias of this test method has not been determined at this time.

## 14. Settling Rate of Hydrated Lime

#### 14.1 Significance and Use:

14.1.1 This test method provides a measure of the rate of settling of a hydrated lime slurry, a form in which this material is frequently used. In some applications a slow settling slurry is desirable; in others, fast settling is preferred.

#### 14.2 Procedure:

14.2.1 Place 10.0 g of lime hydrate in a 100-mL glass-stoppered graduated cylinder (internal diameter about 24 mm). Wet with 50 mL of carbon dioxide ( $\text{CO}_2$ ) free distilled water at  $23 \pm 1.7$  °C ( $73.4 \pm 3$  °F) and mix thoroughly by alternately inverting and righting the cylinder slowly for a period of 2 min. Allow the graduate and contents to stand at  $23 \pm 1.7$  °C for 30 min and then dilute to the 100-mL mark with  $\text{CO}_2$ -free distilled water at  $23 \pm 1.7$  °C. Mix contents again thoroughly as before and allow to stand undisturbed at  $23 \pm 1.7$  °C for 24 h.

#### 14.3 Report:

<sup>10</sup> Distilled or deionized water should be used for milling solution or solubility tests.

<sup>11</sup> U.S. Standard Sieves 6, 20, 40 and 200 mesh sizes; 20.3 cm (8 in.) diameter by 5 cm (2 in.) depth with stainless steel wire cloth.



14.3.1 Report the sedimentation height in millilitres after  $\frac{1}{4}$ ,  $\frac{1}{2}$ ,  $\frac{3}{4}$ , 1, 2, 4, and 24 h, reading the bottom of the meniscus.

NOTE 10—Slight variations in results of this test method on a sample run in different laboratories or by different operators are permissible. The test is not an absolute one, but is designed to distinguish between fast and slow settling hydrates.

#### 14.4 Precision and Bias:

14.4.1 No precision data are available due to the limited use of this test method. Therefore, users are advised to develop their own laboratory precision.

### PARTICLE SIZE ANALYSIS

## 15. Residue and Sieve Analysis

### 15.1 Significance and Use:

15.1.1 This test method determines the residue obtained from slaking quicklime. Residue, in this case, is largely unreacted material such as uncalcined limestone or dolomite, overburned quicklime, or gross impurities, or a combination of these.

### 15.2 Apparatus:

15.2.1 The sieves used shall conform to the requirements of Specification E 11. Preferably the sieves should have a 4-in. depth.

15.2.2 If sieve calibrations are required, follow the method as outlined in Test Method C 430.

15.2.3 *Spray Nozzle*, conforming to the requirements of Test Method C 430.

15.2.4 *Pressure Gage* shall be 3-in. (75-mm) minimum diameter, and shall be graduated in 1-psi (6.9 kPa) increments, and shall have a maximum capacity of 30-psi (207 kPa). The accuracy at 10 psi (69 kPa) shall be  $\pm 0.25$  psi ( $\pm 1.7$  kPa).

15.2.5 Attach a pressure gage to the water faucet and a rubber tubing to the output side of the pressure gage. On the other end of the rubber tubing attach the spray nozzle (see 15.2.3).

### 15.3 Residue of Quicklime:

15.3.1 Select a representative 2.5-kg (5-lb) sample of the quicklime. Break lime selected for this test so as to entirely pass a 25.0-mm (1-in.) square mesh screen. Test the pulverized lime as received. Place the sample in a box of wood or of some material of similarly low thermal conductivity, and an experienced operator should slake it with sufficient water at 21 to 27 °C (70 to 80 °F) to produce the maximum quantity of lime putty, carefully avoiding “burning” or “drowning” the lime. Allow it to stand for 1 h and then wash through an 850- $\mu$ m (No. 20) sieve by a stream of water having a moderate pressure. Do not rub any material through the sieve. Continue the washing until the residue on the screen appears to consist entirely of coarse particles, but in no case continue the washing for more than 30 min. Dry the residue to constant weight at a temperature of 100 to 107 °C (212 to 225 °F) and calculate the percentage residue, based on the original weight of the sample.

### 15.4 Sieve Analysis of Hydrated Lime:

15.4.1 Select a 100-g sample of the hydrated lime as received and place on a 600- $\mu$ m (No. 30) sieve, which is nested above a 75- $\mu$ m (No. 200) sieve. Wash the material through the sieves by means of a stream of water from the nozzle attached

to a rubber tubing (see 15.2.5) after adjusting the water pressure to 10 psi (69 kPa)  $\pm 0.25$  psi ( $\pm 1.7$  kPa). Carefully wash the sample through the sieves without allowing any splashing over the sides of the sieve. After the sample is washed through the top sieve, separate the two sieves and continue washing through the 75- $\mu$ m (No. 200) sieve until the water coming through the sieve is clear, that is, no particles can be seen in a beaker of the rinse water, but in no case continue the washing longer than 30 min. Take care not to let water accumulate on the 75- $\mu$ m (No. 200) sieve, because the openings will become clogged and the operation cannot be completed in 30 min.

15.4.2 Calculate the percentage residue retained on each sieve, based on the original weight of the sample. The weight of the material retained on the 600- $\mu$ m (No. 30) sieve shall be added to the weight of the material retained on the 75- $\mu$ m sieve to obtain the correct weight of the material retained on the 75- $\mu$ m sieve.

### 15.5 Sieve Analysis of Limestone and Dry Quicklime:

15.5.1 Select the desired sieves and nest them with the coarsest sieves on top. Weigh a 100-g sample of the material to be tested and place it on the top sieve. Conduct the sieving operation by means of a lateral and vertical motion of the sieve accompanied by a jarring action to keep the sample moving continuously over the surface of the sieve. Continue sieving until not more than 1 % of the residue passes any sieve during 1 min. If mechanical sieving is used, the device shall be such as to impart the type of agitation described in the hand sieving operation. Continue the shaking for a period of 15 min.

15.5.2 Weigh the residue retained on each sieve to the nearest 0.1 g. Report the results of the sieve analysis as follows: (1) total percentages passing each sieve, (2) total percentages retained on each sieve, or (3) percentages retained between consecutive sieves, depending upon the form of the specification for the use of the material under test.

### 15.6 Precision and Bias:

15.6.1 No precision data are available due to the limited use of these test methods. Therefore, users are advised to develop their own laboratory precision. No statement is being made about the bias of these test methods.

## 16. Fineness of Pulverized Quicklime and Hydrated Lime by Air Permeability

### 16.1 Significance and Use:

16.1.1 This test method covers the determination of fineness of pulverized quicklime and hydrated lime using the Blaine air permeability apparatus described in Test Method C 204. Fineness in terms of surface area shall be expressed as total surface area in square centimetres per gram, or square metres per kilogram.

16.1.2 This test method provides, in general, relative rather than absolute fineness values. For the complete description of the apparatus and the procedures for use, refer to Test Method C 204.

### 16.2 Precision and Bias:

16.2.1 Although precision for the test method for fineness of portland cement by air permeability apparatus has been reported in Test Method C 204, the precision of this test method has not been determined for pulverized lime and hydrated lime.

When sufficient data has been obtained and analyzed, a statement of precision will be provided. In the meantime users of this test method are advised to develop their own.

## 17. Particle Size of Pulverized Limestone

### 17.1 Significance and Use:

17.1.1 Particle size of pulverized limestone, as the word is used in these methods, is the percent distribution of the equivalent spherical diameter of the individual particles expressed in micrometres, using the principle of sedimentation and Stokes' law for particle size determination. It is intended for use with pulverized limestones with not more than 0.5 % residue on a 45- $\mu\text{m}$  (No. 325) sieve.

### 17.2 Apparatus:

17.2.1 *Soil Hydrometer*, ASTM 152H.

17.2.2 *Sedimentation Cylinder*, ASTM, 1000-mL capacity.

17.2.3 *Rubber Stopper*, Size 12.

17.2.4 *Thermometer*, 0 to 105 °C.

17.2.5 *Stop Watch*.

17.2.6 *Regular Clock or Watch*.

17.2.7 *Mixer*.

17.2.8 *Water Bath*.

17.2.9 *Balance*.

17.2.10 *Watch Glass*.

17.2.11 *Graph Paper*, 3 cycles  $\times$  70 divisions.

17.2.12 *Sieve*, 45- $\mu\text{m}$  (No. 325), stainless steel cloth, brass frame, 8-in. diameter.

17.2.13 *Sieve*, 500-mesh, stainless steel cloth, brass frame, 4-in. diameter, 5-in. tall frame.

### 17.3 Reagents:

17.3.1 *Particle-Dispersing Agent*, (30 mL of 25 % solution is diluted up to 400 mL with distilled water).

### 17.4 Procedure:

17.4.1 Determine meniscus correction by inserting the hydrometer in the sedimentation cylinder filled to mark with distilled water. Record the reading at the top of the meniscus and at the bottom of the meniscus. The difference between the two readings is the meniscus correction. For example, in Fig. 7, the correction for the hydrometer used is 1.2. This reading is added to each  $R$  to obtain  $R_r$ .

17.4.2 Calibrate the hydrometer by adding 30 mL of the particle-dispersing solution to the sedimentation cylinder, then bringing up to the mark with distilled water at 27 °C. Mix thoroughly and take a hydrometer reading (read at the top of the meniscus). Repeat after cooling the cylinder to 17 °C and adjusting the meniscus so it is on the mark. Assume a straight-line relationship and draw a line that gives the *composite correction factor*. This factor is the difference between the reading and zero. These are the corrections entered in Table 7 and should be determined for each hydrometer. Four factors are compensated for in the correction factor: (1) *Temperature*: Hydrometers and cylinders are calibrated at 20 °C; variations from this temperature produce inaccuracy in the hydrometer reading; (2) *Specific gravity*: Addition of dispersant changes the specific gravity of the solution; (3) *Meniscus correction*: Hydrometers are graduated to read at the bottom of the meniscus but opaque calcium carbonate solutions require readings at the top of the meniscus; and (4) *Hydrometers*: In spite of the supposed similarity in volume of the hydrometers

(ASTM 152H), variations of as much as 1.0-scale divisions between two similar hydrometers have been noted. The correction factor brings all four into line with one another. It is not necessary to repeat this calibration unless changing to a different hydrometer.

17.4.3 Weigh 40 g of sample.

17.4.4 Add approximately 300 mL of distilled water to the mixer, 30 mL of the particle-dispersing solution, followed by 40 g of unknown sample. Cover. Agitate for exactly 2 min at high speed.

17.4.5 Transfer the slurry quantitatively to the 1000-mL sedimentation cylinder. Make up to approximately 3.2 mm ( $\frac{1}{8}$  in.) above the mark since it must be read from the top (as the bottom of the meniscus is not visible) and this will approximate the 1000-mL calibration of the cylinder. Cylinder temperature can be adjusted to 20 °C by running cool water on the outside of the cylinder and stirring with a thermometer until 20 °C is reached. Cap with the rubber stopper. Mix well by inverting the cylinder 15 or more times. Remove the stopper and put the cylinder in a water bath that has been previously adjusted to as close to 20 °C as is possible. Start the stop watch and note the time on the clock. At exactly 4½ min after start, carefully insert the hydrometer to the approximate point where the reading is to be made. Take the reading at exactly 5 min. Record the reading and temperature (Note 11). Remove the hydrometer and wash clean of any slurry. Cover the cylinder with the watch glass.

NOTE 11—Temperature must be taken inside the cylinder and not in the water bath.

17.4.6 Take additional readings at 15, 30, 60, 120, or 180 min; 300 or 360 min; and 1200 or 1440 min after the start.

17.4.7 Take a 25-g sample and run a 500-mesh wet-sieve test. The opening of the 500-mesh sieve is approximately 25  $\mu\text{m}$ . From this result calculate the percent finer than 25  $\mu\text{m}$ . Do not discard the plus 500-mesh but use this with the 45- $\mu\text{m}$  (No. 325) sieve to obtain the percent finer than 44  $\mu\text{m}$ . The opening of the 45- $\mu\text{m}$  sieve is 44  $\mu\text{m}$ .

### 17.5 Calculation:

17.5.1 Arrange the data on a sample sheet.

17.5.2 Record the date and clock readings as readings are taken.

17.5.3 Readings are usually taken at 5, 15, 30, 60, 180, 360, and 1440 min. The 25- $\mu\text{m}$  point is obtained from the 500-mesh sieve result and the 44- $\mu\text{m}$  point is obtained from the 45- $\mu\text{m}$  sieve result.

17.5.4 Record the temperature,  $T$ , and the hydrometer reading,  $R$ , for each reading.

17.5.5 Obtain  $R_r$  by adding the meniscus correction to each  $R$  value.

17.5.6 Obtain  $R_c$ , the corrected hydrometer reading, from Fig. 7. This value can be different for each hydrometer and must be individually determined.

17.5.7 Obtain  $L$  from Table 8 using  $R_r$  values.

17.5.8  $\sqrt{L/T}$  is found from Fig. 8 and the values for  $L$  and  $T$  (time). For times not in Fig. 8, calculate the  $\sqrt{L/T}$  since the values for  $L$  and  $T$  (in minutes) are known.

17.5.9 Find  $D$  at 20 °C in terms of  $\sqrt{L/T}$  using Table 9.

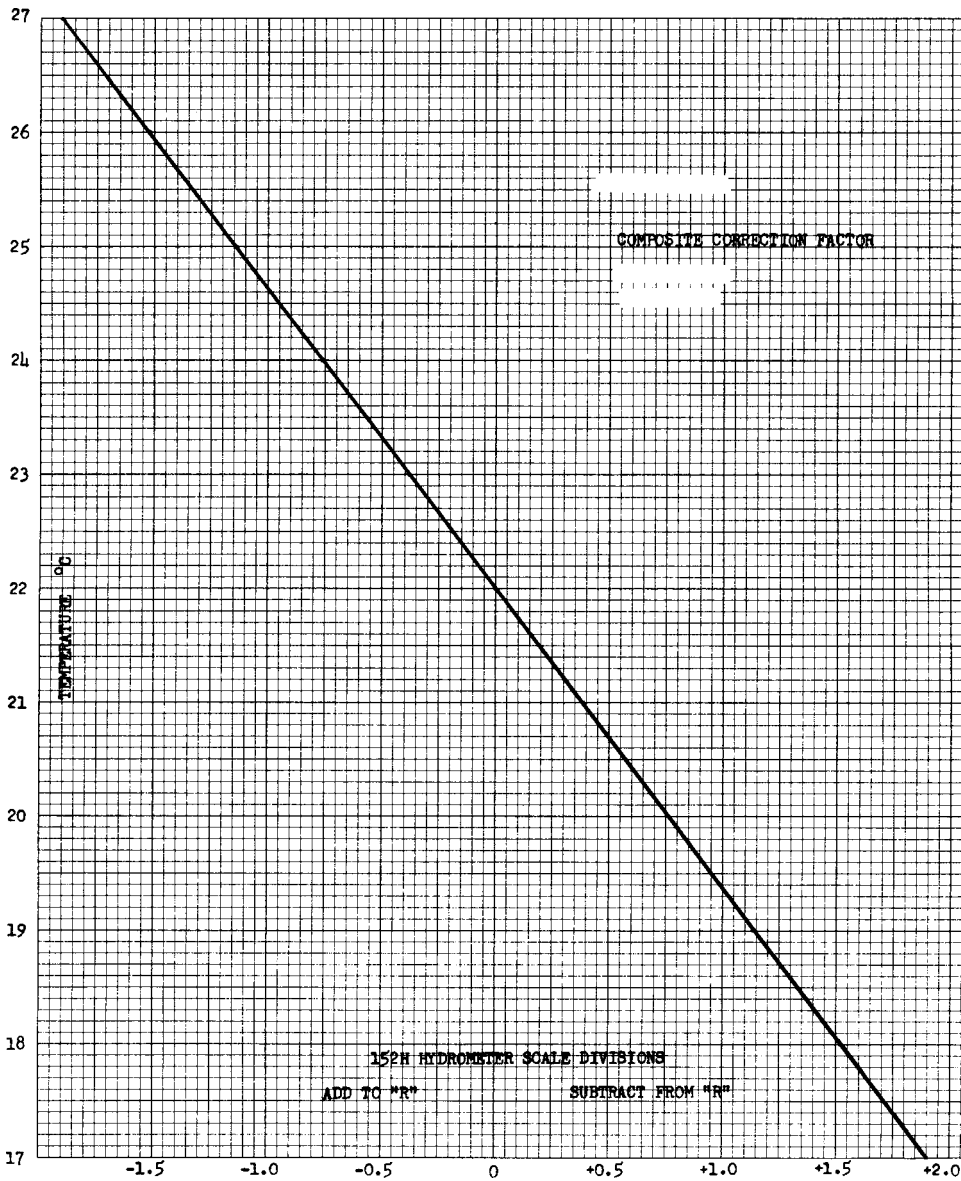

FIG. 7 Composite Correction Factor for Hydrometer

TABLE 7 Hydrometer Composite Correction Factor

Temperature, °C	Correction Factor
17	+1.90
18	+1.52
19	+1.14
20	+0.76
21	+0.39
22	0.00
23	-0.38
24	-0.76
25	-1.14
26	-1.52
27	-1.90

17.5.10 . To correct  $D$  for temperature, use Table 10 and find  $\Delta D$  in terms of  $\sqrt{LT}$  . Multiply by  $\Delta T$  ( $\Delta T$  is the difference in temperature between 20 °C and the actual temperature of the test). This will give a value to be subtracted

from the  $D$  found in 17.5.9 if the temperature is above 20 °C. If the temperature is below 20 °C, this correction should be added.

17.5.11 Find  $P$  by using Table 10 and the value for  $R_c$ .

17.5.12 The values of  $D_c$  are now plotted against the values of  $P$ .

17.6 Precision and Bias:

17.6.1 The precision and bias of this test method has not been determined.

18. Dry Screening of Hydrated Lime, Pulverized Quicklime, and Limestone by Air Jet Sieving

18.1 Significance and Use:

18.1.1 This test method uses a rotating slit nozzle to supply a stream of air directed at the backside of a test sieve, keeping the screen from “blinding.” The aerated material is then pulled back through the sieve by a vacuum source.

**TABLE 8 Effective Depth,  $L$ , for Hydrometer 152H**

$R_r$	$L$ , cm	$R_r$	$L$ , cm
0	16.3	31	11.2
1	16.1	32	11.1
2	16.0	33	10.9
3	15.8	34	10.7
4	15.6	35	10.6
5	15.5	36	10.4
6	15.3	37	10.2
7	15.2	38	10.1
8	15.0	39	9.9
9	14.8	40	9.7
10	14.7	41	9.6
11	14.5	42	9.4
12	14.3	43	9.2
13	14.2	44	9.1
14	14.0	45	8.9
15	13.8	46	8.8
16	13.7	47	8.6
17	13.5	48	8.4
18	13.3	49	8.3
19	13.2	50	8.1
20	13.0	51	7.9
21	12.9	52	7.8
22	12.7	53	7.6
23	12.5	54	7.4
24	12.4	55	7.3
25	12.2	56	7.1
26	12.0	57	7.0
27	11.9	58	6.8
28	11.7	59	6.6
29	11.5	60	6.5
30	11.4		

18.1.2 The advantages of dry screening by air jet sieving are twofold. The material being tested is less likely to “blind” the screen because of the recurring counterflow of an air stream to the back of the sieve. Also, dry screening avoids the error introduced by the interaction of the test material with soluble liquid media.

18.1.3 This test method is suitable for screening material from a nominal 300  $\mu\text{m}$  (50 mesh) in size to 20  $\mu\text{m}$  (635 mesh).

NOTE 12—Blinding of the sieves can occur at various sizes depending on the materials being sieved. Experience has shown 45  $\mu\text{m}$  (325 mesh) to be the lower limit with some hydrates. Other hydrates and pulverized quicklime may be sieved to 32  $\mu\text{m}$  (450 mesh). Limestone can be sieved to 20  $\mu\text{m}$  (635 mesh).

### 18.2 Apparatus:

18.2.1 *An Enclosed Device*, capable of creating a vacuum on the backside of a sieve causing a rotating slit nozzle to supply an air stream perpendicular to the bottom of the sieve. The purpose is to suspend all material on the sieve by the air stream on a rotating basis.<sup>12</sup>

18.2.2 *Balance*, suitable for weighing accurately to 0.01 g.

NOTE 13—Selection of balance with regard to accuracy is dependent on the sample size chosen and residue retained and must be consistent with

<sup>12</sup> The apparatus describes commercially available units sold by the Alpine American Corporation of Natick, Massachusetts. Although the description of the apparatus is directed toward this commercially available equipment, it does not restrict the use of other equivalent equipment which may be available or may be constructed, as long as it follows the general principles outlined under the summary of this test method.

the accuracy required. Therefore, a balance weighing accurately to 0.001 g may be desired.

18.2.3 *Brush*, soft bristle.

18.2.4 *Sieve Cover*—A hard plastic transparent cover used to create a vacuum on the sieve.

18.2.5 *Test Sieves*—The sieves should be constructed using a woven wire, either brass or stainless steel, mounted on a substantial frame. Electroformed sieves are not recommended because of increased blinding and cleaning problems, making them impractical to use under most conditions. The sieves shall be approximately 8 in. in diameter and conform to Specification E 11. A flexible collar must be used to ensure an air tight fit between the sieve and the device.

### 18.3 Procedure:

18.3.1 After placing the appropriate sieve into position, weigh (to the nearest 0.01 g) a sample of the test material and place it on the sieve.

NOTE 14—The accuracy of sieve analysis with products with fine particle size distributions such as Type S hydrated lime can be improved by adding graphite powder (nominal 20  $\mu\text{m}$  (625 mesh)) to the sample. For every 20 g of sample, 0.5 g of graphite should be added.

NOTE 15—The amount of sample and duration of sieving are dependent upon the type of material and gradation and therefore should be adapted to individual conditions. Generally, the larger the sample size, the more representative of the material tested and the less significant are errors of technique, therefore, the results are the more exact. Sample weights can vary from 20 g for material finer than 40  $\mu\text{m}$  up to 50 g for larger, heavier materials.

18.3.2 Place cover on sieve, set timer to 6 min and start vacuum (maintain vacuum according to manufacturer’s recommendation). Any material clinging to the cover or edge of the sieve can be removed by light tapping with a mallet or similar device (see Note 15). If agglomerations form, they can be broken apart with a soft bristle brush.

NOTE 16—Static electrical charges can often develop on the cover (if it is made of plastic) causing it to hold a heavy film of the material being sieved. If tapping will not loosen the material, a static face sheet<sup>13</sup> may be used to wipe the cover surface before starting the test.

18.3.3 After screening, clean the sieve with a fine bristle brush being careful not to damage the mesh and then weigh the residue to the nearest 0.01 g.

### 18.4 Calculation:

18.4.1 Calculate percent passing as follows:

$$[(S - R)/S] \times 100 = \text{percent passing} \quad (5)$$

where:

$S$  = sample weight, g, and

$R$  = weight of sieve residue, g.

### 18.5 Precision and Bias:

18.5.1 There are as yet insufficient analyzed data to permit preparation of a precision and bias statement for this test method.

## 19. Wet Sieve Analysis of Agricultural Liming Materials

### 19.1 Scope:

19.1.1 This test method covers the determination of gradation of an Agricultural Liming material by wash. Material finer

<sup>13</sup> Commercially available.



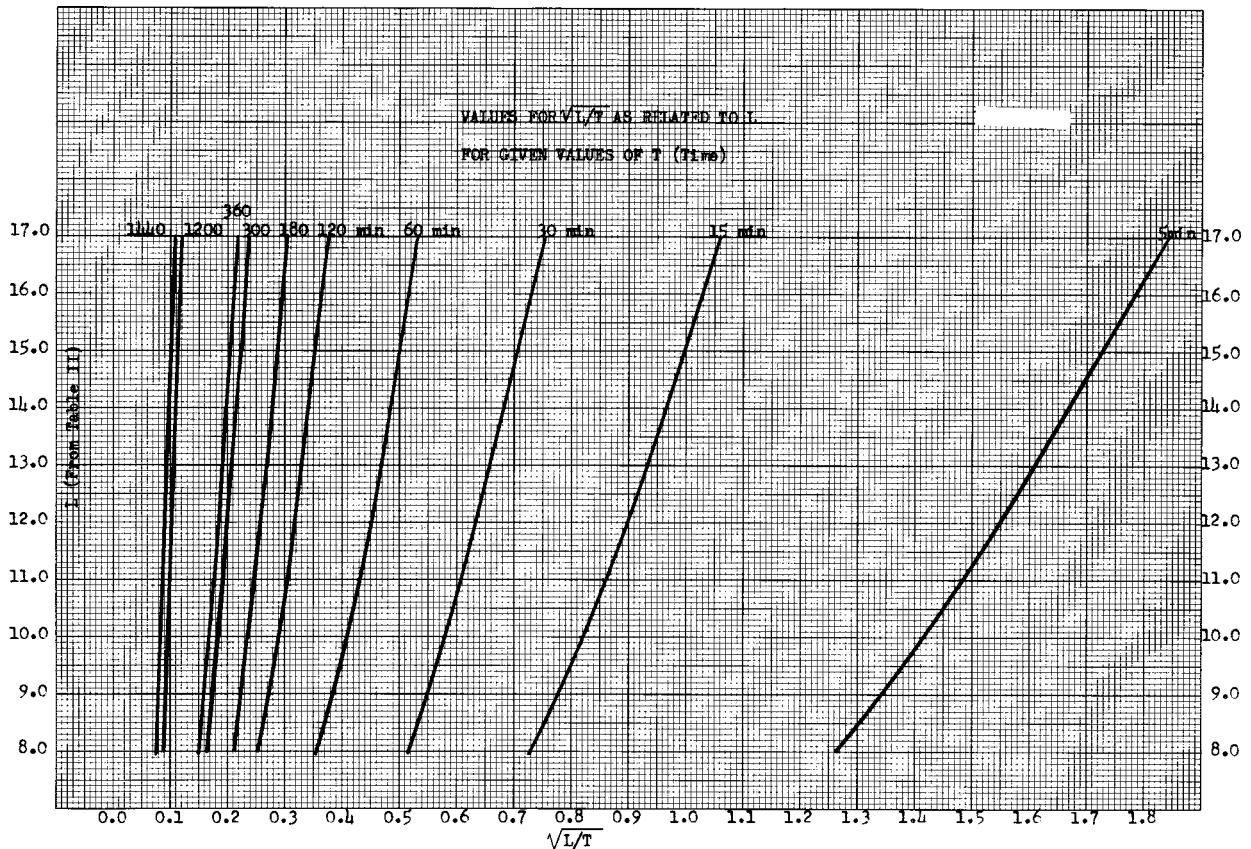

**FIG. 8 Values for  $\sqrt{L/T}$  as Related to  $L$  for Given Values of  $T$  (Time)**

**TABLE 9  $D$  as Related to  $\sqrt{L/T}$  at 20 °C**

$\sqrt{L/T}$	$D, \mu\text{m}$	$\sqrt{L/T}$	$D, \mu\text{m}$
0.05	0.7	1.05	14.0
0.10	1.4	1.10	14.7
0.15	2.0	1.15	15.4
0.20	2.7	1.20	16.0
0.25	3.4	1.25	16.7
0.30	4.0	1.30	17.4
0.35	4.7	1.35	18.0
0.40	5.4	1.40	18.7
0.45	6.0	1.45	19.4
0.50	6.7	1.50	20.1
0.55	7.4	1.55	20.8
0.60	8.0	1.60	21.4
0.65	8.7	1.65	22.1
0.70	9.4	1.70	22.8
0.75	10.0	1.75	23.4
0.80	10.7	1.80	24.1
0.85	11.4	1.85	24.8
0.90	12.0		
0.95	12.7		
1.00	13.4		

**TABLE 10  $\Delta D$  from  $\sqrt{L/T}$**

$\sqrt{L/T}$	$\Delta D$
2.0	0.32
1.9	0.31
1.8	0.29
1.7	0.27
1.6	0.26
1.5	0.24
1.4	0.23
1.3	0.21
1.2	0.19
1.1	0.18
1.0	0.16
0.9	0.15
0.8	0.13
0.7	0.11
0.6	0.10
0.5	0.08
0.4	0.07
0.3	0.05
0.2	0.03
0.1	0.02

than 75 micrometres (No. 200) sieve will be removed from the aggregate during the test, prior to dry sieving of the coarser fraction.

19.1.2 The results of this procedure can be used to determine compliance to a particle size distribution relative to applicable specifications for agricultural liming materials.

19.1.3 This method can **not** be used for the sieve analysis of quicklime or materials containing quicklime, because of the exothermic reaction with water.

#### 19.2 Significance and Use:

19.2.1 Material finer than the 75 micrometres (No. 200) sieve can be separated from larger particles more efficiently

**TABLE 11 Values for  $P$  as Related to  $R_c$ , Using  $a = 0.988$  and  $W = 40$**

NOTE 1—Calculate to nearest 0.1 of  $R_c$ . For a reading of 24.7, take reading of 24.5 which is 60.0 and add  $2 \times 0.4$  or 60.8%.

$R_c$	$P$	$R_c$	$P$	$R_c$	$P$	$R_c$	$P$
0.0	0.0	11.5	28.5	23.0	57.0	34.5	85.0
0.5	1.5	12.0	30.0	23.5	58.0	35.0	86.5
1.0	2.5	12.5	31.0	24.0	59.0	35.5	87.5
1.5	3.5	13.0	32.0	24.5	60.0	36.0	89.0
2.0	5.0	13.5	33.5	25.0	62.0	36.5	90.0
2.5	6.0	14.0	35.0	25.5	63.0	37.0	91.5
3.0	7.5	14.5	36.0	26.0	64.0	37.5	92.5
3.5	8.5	15.0	37.5	26.5	65.0	38.0	94.0
4.0	10.0	15.5	38.5	27.0	66.5	38.5	95.0
4.5	11.0	16.0	39.5	27.5	67.5	39.0	96.5
5.0	12.5	16.5	40.5	28.0	69.0	39.5	97.5
5.5	13.5	17.0	42.0	28.5	70.0	40.0	99.0
6.0	15.0	17.5	43.0	29.0	71.5	40.5	100.0
6.5	16.0	18.0	44.5	29.5	72.5		
7.0	17.5	18.5	45.5	30.0	74.0		
7.5	18.5	19.0	47.0	30.5	75.0		
8.0	20.0	19.5	48.0	31.0	76.5		
8.5	21.0	20.0	49.5	31.5	77.5		
9.0	22.5	20.5	50.5	32.0	79.0		
9.5	23.5	21.0	52.0	32.5	80.0		
10.0	25.0	21.5	53.0	33.0	81.5		
10.5	26.0	22.0	54.5	33.5	82.5		
11.0	27.5	22.5	56.5	34.0	84.0		

and completely by wet sieving than through the use of dry sieving. In sieving fine aggregate, the finer fractions can adhere to the coarser fractions through a normal dry sieving operation. Further, due to electrostatic charges, fine material can also adhere to the coarser sieves. By removing the finer fractions through the wash test, these problems are avoided. Therefore, when an accurate determination of an agricultural liming material is desired, this test method should be used.

19.2.2 The results of this test method are included in the calculation of gradation, and the total amount of material finer than 75 micrometres by washing, plus that obtained by dry sieving the same sample, is reported with the results. Usually the additional amount of material finer than 75 micrometres obtained in the subsequent dry sieving process is a small amount. If it is large, the efficiency of the washing operation should be checked. It could, also, be an indication of degradation of the material.

### 19.3 Apparatus and Materials:

19.3.1 *Balance*—A balance or scale readable and accurate to 0.1 g or 0.1 % of the test load, whichever is greater, at any point within the range of use.

19.3.2 *Sieves*—The sieves shall be mounted on substantial frames, either full height or extended, and constructed in a manner that will prevent loss of material during sieving. The sieves shall be of equal diameter and shape to allow for nesting. The sieves shall conform to Specification E 11.

19.3.3 *Sieve Pan*—A pan of the same diameter as the sieves.

19.3.4 *Container*—A pan or vessel of a size sufficient to contain the sample covered with water and to permit vigorous agitation without loss of any part of the sample or water.

19.3.5 *Oven*—An oven of sufficient size, capable of maintaining a uniform temperature of  $110 \pm 5$  °C.

NOTE 17—The use of a mechanical apparatus to perform the washing

operation is not precluded, provided the results are consistent with those obtained using manual operations. The use of some mechanical washing equipment with some samples may cause degradation of the sample.

### 19.4 Sampling:

19.4.1 Since sampling is equally as important as testing, it is critical that samples be obtained that are representative of the materials being investigated. Therefore, sampling must be conducted in as conscientious a manner as possible. Incremental sampling should be employed, combining the increments into one bulk sample.

19.4.2 Use the procedures described in Practice C 50, or Practice D 75.

19.4.3 To reduce the bulk sample to the amount needed for testing, the use of mechanical splitters or the process of quartering must be used. At no time can a random lot be drawn from the bulk sample for testing.

### 19.5 Procedure:

19.5.1 Dry the test sample to constant mass at a temperature of  $110 \pm 5$  °C. Determine the mass to the nearest 0.1 % of the mass of the test sample. The amount of sample required for this test shall be between 200 to 400 g. The test sample shall be the end result of the reduction. Reduction to an exact predetermined mass shall not be permitted.

19.5.2 After drying and determining the mass, place the test sample in the container and add sufficient water to cover it. Agitate the sample with sufficient vigor to result in complete separation from the coarser particles of all particles finer than the 75 micrometre sieve from the coarser particles, and to bring the fine material into suspension. Immediately pour the wash water containing the suspended and dissolved solids over the nested sieves (see Note 18), arranged with the coarser sieve on top. Take care to avoid, as much as feasible, the decantation of coarser particles of the sample.

NOTE 18—It is recommended that a #16 mesh sieve or one of approximate size be used to nest on top of the # 200 mesh sieve for protection from the sample.

19.5.3 Add a second charge of water to the sample in the container, agitate, and decant as before. Repeat this operation until the wash water is clear (see Note 19).

NOTE 19—If mechanical washing equipment is used, the charging of water, agitating, and decanting may be a continuous operation.

19.5.4 Return all material retained on the nested sieves by flushing to the washed sample. Dry the washed material to constant mass at a temperature of  $110 \pm 5$  °C and determine the mass to the nearest 0.1 g. Calculate the amount of material passing a 75 micrometre sieve by washing according to 19.6.1.

19.5.5 Select the sieves of a suitable size as desired or required by specification and those sieves necessary to regulate the amount of material between the various screens. Nest the screens in order of decreasing size of opening, from top to bottom, on a sieve pan. Be sure to nest the 75 micrometre sieve just above the pan. Place the dried sample on the top sieve. Shake the nested sieves briskly or by use of a mechanical device for a sufficient period to assure that the sample has been adequately screened (see Note 20).

NOTE 20—To be adequately screened, no more than 1 % of the residue on any individual sieve will pass that sieve during 1 min. of continuous

sieving. For a more detailed explanation refer to C 136-84a, paragraph 7.4.

19.5.6 The amount of material on an eight inch sieve after shaking is limited to approximately 200 g, so that all particles during a test have access to the screen medium (see Note 21). If the amount remaining on a sieve is greater than 200 g, the sieve analysis must be repeated. Place an intermediate sieve between the overloaded sieve and the one nested above.

NOTE 21—A twelve inch screen can be used, but the amount of material retained on a sieve is limited to 6 kg/m<sup>2</sup>.

19.5.7 Record the weight of material from each size increment and the sieve pan by weighing on a balance to the nearest 0.1 g (see Note 22). Total the retained masses of all the size increments and the sieve pan from the dry sieve test. If this amount differs from the dry mass of the sample after washing by more than 0.3 %, the results should not be used for acceptance purposes.

NOTE 22—A soft bristle can be used to help remove material from sieves, but at no time can material be forced through a sieve.

#### 19.6 Calculation:

19.6.1 Calculate the amount of a material passing a 75 micrometre sieve by washing as follows:

$$A = [(B - C) / B] \times 100 \quad (6)$$

where:

A = percentage of material finer than a 75 micrometre sieve by washing,

B = original dry mass of sample, g, and

C = dry mass of sample after washing, g.

19.6.2 Calculation of amount of material passing individual sieves follows:

19.6.2.1 Add weight of material finer than a 75 micrometre sieve by washing (B – C, in 19.6.1) to the weight of material finer than a 75 micrometre sieve obtained in the dry screening, if washed.

19.6.2.2 Calculate the percent retained on each sieve and the pan as follows:

$$A = (B / C) \times 100 \quad (7)$$

where:

A = percentage of material retained on each sieve (pan),

B = dry mass of sample, g, retained on each sieve (pan), and

C = original dry mass of sample, g.

19.6.2.3 Calculate the cumulative percent retained for each screen by adding the percentage retained on that sieve and all sieves of larger diameter opening.

19.6.2.4 For each screen, subtract the cumulative percent retained from 100 to obtain the percent passing.

#### 19.7 Precision and Bias:

19.7.1 The precision of this test method is based on an interlaboratory study of C 110 – 01 conducted in 2005. Each of the twelve laboratories tested five different materials. Each “test result” was an individual determination of the percent of material passing a particular mesh sieve. Participating labora-

tories obtained three replicate test results for each material and sieve combination.<sup>14</sup> See Tables 12-16.

19.7.1.1 *Repeatability*—Two test results obtained within one laboratory shall be judged not equivalent if they differ by more than the “r” value for that material; “r” is the interval representing the critical difference between two test results for the same material, obtained by the same operator using the same equipment on the same day in the same laboratory.

19.7.1.2 *Reproducibility*—Two test results should be judged not equivalent if they differ by more than the “R” value for that material; “R” is the interval representing the difference between two test results for the same material, obtained by different operators using different equipment in different laboratories.

19.7.1.3 Any judgment in accordance with these two statements would have an approximate 95 % probability of being correct.

19.7.2 *Bias*—At the time of the study, there was no accepted reference material suitable for determining the bias for this test method, therefore no statement on bias is being made.

19.7.3 The precision and bias statements were determined through statistical examination of 1440 test results, from a total of twelve laboratories, analyzing five materials.

## DENSITY MEASUREMENT

### 20. Apparent Loose Density of Hydrated Lime, Pulverized Quicklime, and Limestone

#### 20.1 Significance and Use:

20.1.1 This test method determines the loose or unsettled density of hydrated lime, pulverized quicklime, and limestone. It provides for an approximate measure of the maximum volume occupied by a given weight of hydrated lime, pulverized quicklime, or limestone.

#### 20.2 Apparatus:

20.2.1 *Flour Sifter*—A 114 to 127 mm (4½ to 5 in.) kitchen-type flour sifter of either the squeeze handle type or the hand crank type. It shall be able to hold at least 300 g of hydrated lime or 500 g of limestone or quicklime. The wire mesh openings should be between 0.8 and 1.5 mm.

20.2.2 *Density Cup*, 400 mL cylindrical cup as described in the Apparatus Section of Test Method C 185.

<sup>14</sup> Supporting data pending being filed at ASTM International Headquarters.

TABLE 12 Screenings

Sieve Size	Average	Repeatability Standard Deviation	Reproducibility Standard Deviation	Repeatability Limit	Reproducibility Limit
	$\bar{x}$	sr	sR	r	R
#200	19.60	0.44	2.26	1.23	6.33
#100	26.66	0.52	2.05	1.46	5.74
#60	32.67	0.26	1.68	0.73	4.70
#36	44.41	0.37	1.28	1.04	3.58
#16	58.60	0.60	1.09	1.68	3.05
#8	78.62	0.71	1.22	1.99	3.42
#4	97.99	0.38	0.47	1.06	1.32
¾”	100.00	0.00	0.00	0.00	0.00

**TABLE 13 Superfine**

Sieve Size	Average	Repeatability Standard Deviation	Reproducibility Standard Deviation	Repeatability Limit	Reproducibility Limit
	$\bar{x}$	sr	sR	r	R
#200	99.94	0.12	0.13	0.34	0.36
#100	99.97	0.07	0.08	0.20	0.22
#60	99.99	0.06	0.05	0.17	0.14
#36	99.99	0.04	0.04	0.11	0.11
#16	99.99	0.03	0.03	0.08	0.08
#8	100.00	0.00	0.00	0.00	0.00
#4	100.00	0.00	0.00	0.00	0.00
3/8"	100.00	0.00	0.00	0.00	0.00

**TABLE 14 Ground**

Sieve Size	Average	Repeatability Standard Deviation	Reproducibility Standard Deviation	Repeatability Limit	Reproducibility Limit
	$\bar{x}$	sr	sR	r	R
#200	73.75	4.39	4.56	12.29	12.77
#100	92.67	4.69	4.67	13.13	13.08
#60	98.19	0.76	0.83	2.13	2.32
#36	99.33	0.13	0.19	0.36	0.53
#16	99.72	0.10	0.15	0.28	0.42
#8	99.91	0.09	0.09	0.25	0.25
#4	99.99	0.02	0.02	0.06	0.06
3/8"	100.0	0.00	0.00	0.00	0.00

**TABLE 15 Meal**

Sieve Size	Average	Repeatability Standard Deviation	Reproducibility Standard Deviation	Repeatability Limit	Reproducibility Limit
	$\bar{x}$	sr	sR	r	R
#200	30.16	1.16	2.27	3.25	6.36
#100	37.00	1.04	1.72	2.91	4.82
#60	42.24	0.84	1.22	2.35	3.42
#36	53.86	0.70	0.99	1.96	2.77
#16	67.00	0.70	1.05	1.96	2.94
#8	86.48	0.75	1.79	2.10	5.01
#4	98.67	0.66	0.63	1.85	1.76
3/8"	99.91	0.30	0.29	0.84	0.81

**TABLE 16 Pulverized**

Sieve Size	Average	Repeatability Standard Deviation	Reproducibility Standard Deviation	Repeatability Limit	Reproducibility Limit
	$\bar{x}$	sr	sR	r	R
#200	87.97	0.88	1.23	2.46	3.44
#100	97.96	0.42	2.98	1.18	8.34
#60	99.77	0.19	0.27	0.53	0.76
#36	99.98	0.05	0.07	0.14	0.20
#16	100.00	0.00	0.00	0.00	0.00
#8	100.00	0.00	0.00	0.00	0.00
#4	100.00	0.00	0.00	0.00	0.00
3/8"	100.00	0.00	0.00	0.00	0.00

mat inserted underneath the cup to collect excess sample spilling over the cup. Fill the flour sifter with more than enough material to fill the density cup. Start the clock and the sifting device to facilitate the flow of powder into the cup. Overflow the cup until there is a cone of excess material.

20.3.2 After 3 min, carefully remove the excess powder by passing the edge of a spatula blade parallel with, and in contact with, the top of the cup. Move the spatula smoothly and keep it level at all times to prevent packing or pulling the sample out of the cup.

20.3.3 After the cup is level, lightly tap it with the edge of the spatula to settle the powder. Wipe the outside of the cup with a lintless cloth or paper towel. Avoid spilling the sample while transferring the cup to the balance for weighing.

20.3.4 Weigh the cup and sample to the nearest 0.1 g and determine the weight of the sample by difference.

20.3.5 The loose density of the material is calculated and reported as grams per cubic centimetre, or as pounds per cubic foot.

#### 20.4 Calculation:

20.4.1 Calculate the loose density as follows:

$$D = W/V \quad (8)$$

where:

$D$  = loose density,

$W$  = weight of sample, g, and

$V$  = volume of cup,  $\text{cm}^3$ .

20.4.2 For reporting as pounds per cubic foot, multiply grams per cubic centimetre by 62.43.

#### 20.5 Precision and Bias:

20.5.1 *Single Operator Precision*—The single operator standard deviation has been found to be 0.4  $\text{lb/ft}^3$  (Note 9). Therefore, results of two properly conducted tests by the same operator on the same material should not differ by more than 1.13  $\text{lb/ft}^3$ .

20.5.2 *Multilaboratory Precision*—The multilaboratory standard deviation has been found to be 1.26  $\text{lb/ft}^3$  (Note 23). Therefore, results of two properly conducted tests from two different laboratories on samples of the same material should not differ by more than 3.6  $\text{lb/ft}^3$ .

NOTE 23—These numbers represent, respectively, the (1s) and (d2s) limits as described in Practice C 670.

20.5.3 The above precision statements are based on a multilaboratory testing program for determination of the loose bulk density of hydrated lime. No statement is made regarding the precision of this method as it relates to other materials. Due to a lack of a recognized industry standard, the bias of this test method has not been determined.

## 21. Apparent Packed Density of Hydrated Lime, Pulverized Quicklime, and Limestone

### 21.1 Significance and Use:

21.1.1 This test method determines the packed or settled density of hydrated lime, pulverized quicklime, and limestone. It provides for determining the minimum volume occupied by a given weight of hydrated lime, pulverized quicklime or limestone.

### 21.2 Apparatus:

20.2.3 *Balance*, suitable for weighing at least 800 g accurately to 0.1 g.

20.2.4 *Clock or Watch*.

20.2.5 *Straight Edge*.

### 20.3 Procedure:

20.3.1 Weigh the empty density cup to the nearest 0.1 g on a balance. Place the tared cup on a solid table with a suitable



21.2.1 *Graduated Cylinder*, 100 mL capacity.

21.2.2 *Balance*, accurate to 0.1 g.

21.3 *Procedure*:

21.3.1 Weigh to within 0.1 g a 25 g sample of powdered material and transfer it to the graduated cylinder.

21.3.2 Allow powder to settle by gently tapping the cylinder on a desk top cushioned with a thick magazine or writing tablet so that compaction occurs without fluffing.

21.3.3 Record the volume of the lime after each 100 taps and continue tapping until compaction volume change is less than 0.5 mL/100 taps.

21.3.4 Calculate the density in grams per cubic centimetre or in pounds per cubic foot to the nearest pound.

21.4 *Calculation*:

21.4.1 Calculate the packed density as follows:

$$D = W/V \quad (9)$$

where:

$D$  = packed density,

$W$  = weight of sample, g, and

$V$  = final volume of sample, cm<sup>3</sup>.

21.4.2 For reporting as pounds per cubic foot, multiply grams per cubic centimetre by 62.43.

21.5 *Precision and Bias*:

21.5.1 *Single Operator Precision*—The single operator standard deviation has been found to be 0.5 lb/ft<sup>3</sup> (Note 23). Therefore, results of two properly conducted tests by the same operator on the same material should not differ by more than 1.4 lb/ft<sup>3</sup>.

21.5.2 *Multilaboratory Precision*—The multilaboratory standard deviation has been found to be 1.7 lb/ft<sup>3</sup> (Note 23). Therefore, results of two properly conducted tests from two different laboratories on samples of the same material should not differ by more than 4.8 lb/ft<sup>3</sup>.

21.5.3 The above precision statements are based on a multilaboratory testing program for determination of the packed bulk density of hydrated lime. No statement is made regarding the precision of this method as it relates to other materials. Due to a lack of a recognized industry standard, the bias of this test method has not been determined.

## 22. Specific Gravity of Hydrated Lime Products

22.1 *Significance and Use*:

22.1.1 This test method covers the determination of the specific gravity of hydrated lime. The specific gravity of hydrated lime is needed for calculations of air content (see Section 8) and Blaine Surface Area.

22.1.2 The specific gravity of hydrated lime is defined as the mass of a unit volume of the solids.

22.2 *Apparatus*:

22.2.1 *Le Chatelier Flask*—The standard flask, which is circular in cross section with shape and dimensions conforming essentially to Fig. 1 of Test Method C 188 (Note 24). The requirements in regard to tolerance, inscription and length, spacing, and uniformity of graduation shall be rigidly observed. There shall be a space of at least 10 mm between the highest graduation mark and the lowest point of grinding for the glass stopper.

22.2.1.1 The material of construction shall be best quality glass, transparent and free of striae. The glass shall be chemically resistant and shall have small thermal hysteresis. The flasks shall be thoroughly annealed before being graduated. They shall be of sufficient thickness to ensure reasonable resistance to breakage.

22.2.1.2 The neck shall be graduated from 0 to 1 mL and from 18 to 24 mL in 0.1 mL graduations. The error of any indicated capacity shall not be greater than 0.05 mL.

22.2.1.3 Each flask shall bear a permanent identification number and the stopper, if not interchangeable ground, shall bear the same number. Interchangeable ground-glass parts shall be marked on both members with the standard-taper symbol followed by the size designation. The standard temperature shall be indicated, and the unit of capacity shall be shown by the letters “mL” placed above the highest graduation mark.

NOTE 24—The design is intended to ensure complete drainage of the flask when emptied, and stability of standing on a level surface, as well as accuracy and precision of reading.

22.3 *Reagents*:

22.3.1 *Ethyl Alcohol (Absolute)*, free of water, shall be used in the density determination. The ethanol used should not have been denatured with methanol.

22.4 *Procedure*:

22.4.1 Determine the specific gravity of hydrated lime on the material as received, unless otherwise specified.

22.4.2 Fill the flask (Note 25) with denatured ethyl alcohol to a point on the stem between the 0 and 1-mL mark. Dry the inside of the flask above the level of the liquid, if necessary, after pouring. Record the first reading after the flask has been immersed in the water bath (Note 26) in accordance with 19.3.4.

NOTE 25—It is advisable to use a rubber pad on the table top when filling or rolling the flask.

NOTE 26—Before the hydrated lime has been added to the flask, a loose fitting lead-ring weight around the stem of the flask will be helpful in holding the flask in an upright position in the water bath, or the flask may be held in the water bath by a buret clamp.

22.4.3 Introduce a quantity of hydrated lime, weighed to the nearest 0.05 g, (about 50 g for hydrated lime) in small increments at the same temperature as the liquid (Note 25). Take care to avoid splashing and see that the hydrated lime does not adhere to the inside of the flask above the liquid. A vibrating apparatus may be used to accelerate the introduction of the hydrated lime into the flask and to prevent the lime from sticking to the neck. After all the hydrated lime has been introduced, place the stopper in the flask and roll the flask in an inclined position (Note 25), or gently whirl it in a horizontal circle as to free the lime from air until no further air bubbles rise to the surface of the liquid. If a proper amount of hydrated lime has been added, the level of the liquid will be in its final position at some point of the upper series of graduations. Take the final reading after the flask has been immersed in the water bath in accordance with 22.3.4.

22.4.4 Immerse the flask in a constant-temperature water bath for sufficient periods of time in order to avoid flask temperature variations greater than 0.2 °C between the initial and final readings.

## 22.5 Calculation:

22.5.1 The difference between the first and the final readings represents the volume of liquid displaced by the mass of hydrated lime used in the test.

22.5.2 Calculate the hydrated lime density,  $p$ , as follows:

$$p(\text{Mg/m}^3) = p(\text{g/cm}^3) = \frac{\text{mass of hydrated lime (g)}}{\text{displaced volume (cm}^3)} \quad (10)$$

NOTE 27—The displaced volume in milliliters is numerically equal to the displaced volume in cubic centimeters.

## 22.6 Precision and Bias:

22.6.1 *Round Robin*—An interlaboratory study, consistent with the guidelines of Practice E 691, was conducted in June 2000. The test for specific gravity was conducted in accordance with these test methods, Section 22. Four hydrated lime products, two dolomitic “S” samples and two Type “N” (one high calcium and one dolomitic) samples were tested by seven laboratories. Each laboratory performed three determinations, thus meeting the requirements of Practice E 691. The research report is on file with ASTM International.<sup>15</sup>

22.6.2 *Precision*—The relative precision of this test method, characterized by repeatability (Sr and r) and reproducibility (SR and R) has been determined for the materials to be the following:

Hydrate Type	Average	Sr	SR	r	R
High Calcium “N”	2.217	0.007	0.030	0.020	0.083
Dolomitic “S”	2.306	0.023	0.059	0.065	0.164
Dolomitic “N”	2.466	0.016	0.035	0.045	0.097

22.6.3 *Repeatability*—Examine the data in 22.6.2 as to hydrate type to determine the expected differences in absolute value of replicate determinations, carried out in the same laboratory, by the same operator using the same apparatus at a 95 % confidence level. The critical value for repeatability is r.

22.6.4 *Reproducibility*—Examine the data in 22.6.2 as to hydrate type to determine the expected differences in absolute value of replicate determinations, carried out in different laboratories using samples taken at random from the same bulk sample. The critical value, R, may be expected to occur at a 95 % confidence level, for reproducibility.

22.6.5 *Bias*—No bias is expected for the method.

## 23. Keywords

23.1 accepted reference value; accuracy; apparent density; bias; dry brightness; dry screening; fineness; interlaboratory study; lime putty; limestone grindability; particle size; precision; precision conditions; repeatability; reproducibility; slaking rate; standard deviation

<sup>15</sup> Supporting data have been filed at ASTM International Headquarters and may be obtained by requesting Research Report RR: C07-1004.

## SUMMARY OF CHANGES

Committee C07 has identified the location of selected changes to these test methods since the last issue, C 110 – 08a, that may impact the use of these test methods. (Approved March 1, 2009)

(1) Revised Table 3.

(2) Revised Note 14.

Committee C07 has identified the location of selected changes to these test methods since the last issue, C 110 – 08, that may impact the use of these test methods. (Approved December 1, 2008)

(1) Revised 7.4.1 and 7.4.2.1.

(2) Moved old Section 22 Wet Sieve Analysis of Agricultural Liming Materials to Section 19 and renumbered subsequent sections. Added a precision and bias statement to Section 19.

Committee C07 has identified the location of selected changes to these test methods since the last issue, C 110 – 06, that may impact the use of these test methods. (Approved June 1, 2008)

(1) Revised the precision and bias statement in 6.5. Added new Tables 1 and 2 and renumbered subsequent tables. Added new Footnote 6 and renumbered subsequent footnotes.

(2) Revised 7.1.1.

(3) Added new Footnote 7 and renumbered subsequent footnotes.

*ASTM International takes no position respecting the validity of any patent rights asserted in connection with any item mentioned in this standard. Users of this standard are expressly advised that determination of the validity of any such patent rights, and the risk of infringement of such rights, are entirely their own responsibility.*

*This standard is subject to revision at any time by the responsible technical committee and must be reviewed every five years and if not revised, either reapproved or withdrawn. Your comments are invited either for revision of this standard or for additional standards and should be addressed to ASTM International Headquarters. Your comments will receive careful consideration at a meeting of the responsible technical committee, which you may attend. If you feel that your comments have not received a fair hearing you should make your views known to the ASTM Committee on Standards, at the address shown below.*

*This standard is copyrighted by ASTM International, 100 Barr Harbor Drive, PO Box C700, West Conshohocken, PA 19428-2959, United States. Individual reprints (single or multiple copies) of this standard may be obtained by contacting ASTM at the above address or at 610-832-9585 (phone), 610-832-9555 (fax), or [service@astm.org](mailto:service@astm.org) (e-mail); or through the ASTM website ([www.astm.org](http://www.astm.org)).*