



# Standard Test Method for Annealing Point and Strain Point of Glass by Beam Bending<sup>1</sup>

This standard is issued under the fixed designation C 598; the number immediately following the designation indicates the year of original adoption or, in the case of revision, the year of last revision. A number in parentheses indicates the year of last reapproval. A superscript epsilon ( $\epsilon$ ) indicates an editorial change since the last revision or reapproval.

## 1. Scope

1.1 This test method covers the determination of the annealing point and the strain point of a glass by measuring the rate of midpoint viscous bending of a simply loaded glass beam.<sup>2</sup> However, at temperatures corresponding to the annealing and strain points, the viscosity of glass is highly time-dependent. Hence, any viscosities that might be derived or inferred from measurements by this procedure cannot be assumed to represent equilibrium structural conditions.

1.2 The annealing and strain points shall be obtained following a specified procedure after direct calibration of the apparatus using beams of standard glasses having known annealing and strain points such as those supplied and certified by the National Institute of Standards and Technology.<sup>3</sup>

1.3 This test method, as an alternative to Test Method C 336 is particularly well suited for glasses that for one reason or another are not adaptable for flame working. It also has the advantages that thermal expansion and effective length corrections, common to the fiber elongation method, are eliminated.

1.4 The values stated in metric units are to be regarded as the standard. The values given in parentheses are for information only.

1.5 *This standard does not purport to address all of the safety concerns, if any, associated with its use. It is the responsibility of the user of this standard to establish appropriate safety and health practices and determine the applicability of regulatory limitations prior to use.*

<sup>1</sup> This test method is under the jurisdiction of ASTM Committee C14 on Glass and Glass Products and is the direct responsibility of Subcommittee C14.04 on Physical and Mechanical Properties.

Current edition approved April 1, 2008. Published December 2008. Originally approved in 1967. Last previous edition approved in 2003 as C 598 – 93 (2003).

<sup>2</sup> Hagy, H. E., "Experimental Evaluation of Beam Bending Method of Determining Glass Viscosities in the Range  $10^8$  to  $10^{15}$  Poises," *Journal of the American Ceramic Society*, Vol 46, No. 2, 1963, pp. 95–97.

<sup>3</sup> NIST Special Publication 260.

## 2. Referenced Documents

### 2.1 ASTM Standards:<sup>4</sup>

C 336 Test Method for Annealing Point and Strain Point of Glass by Fiber Elongation

## 3. Terminology

### 3.1 Definitions:

3.1.1 *annealing range*—the range of glass temperature in which stresses in glass articles can be relieved at a commercially desirable rate. For purposes of comparing glasses, the annealing range is assumed to correspond with the temperatures between the annealing point (A. P.) and the strain point (St. P.).

3.1.2 *annealing point*—that temperature at which internal stresses in a glass are substantially relieved in a matter of minutes. During a test in accordance with the requirements of this test method, the midpoint rate of viscous deflection of the test beam is measured by an extensometer with suitable magnification during cooling at a rate of  $4 \pm 1^\circ\text{C}/\text{min}$ . The nominal deflection rate at the annealing point ideally is as follows:

$$\text{Deflection rate, cm/min} = (2.67 \times 10^{-11} L^3 M)/I_c \quad (1)$$

where:

$L$  = support span, cm;

$M$  = centrally applied load, g; and

$I_c$  = cross-section moment of inertia of test beam,  $\text{cm}^4$  (see

Appendix X1).

3.1.3 *strain point*—that temperature at which internal stresses in a glass are substantially relieved in a matter of hours. The strain point is determined by extrapolation of the annealing point data and is the temperature at which the viscous deflection rate is 0.0316 times that observed at the annealing point.

<sup>4</sup> For referenced ASTM standards, visit the ASTM website, [www.astm.org](http://www.astm.org), or contact ASTM Customer Service at [service@astm.org](mailto:service@astm.org). For *Annual Book of ASTM Standards* volume information, refer to the standard's Document Summary page on the ASTM website.

**4. Significance and Use**

4.1 This test method offers an alternate procedure to Test Method C 336 for determining the annealing and strain points of glass. It is particularly recommended for glasses not adaptable to flame working. Also fewer corrections are necessary in data reduction.

**5. Apparatus**

5.1 The apparatus shall consist of a furnace, a means of controlling its temperature and cooling rate, a specimen holder and loading rod, and a means of observing the rate of midpoint viscous deflection of the glass beam.

5.1.1 *Furnace*—The furnace shall be electrically heated by resistance-wire windings of either platinum-rhodium or 80-20 Ni-Cr alloys. A cutaway drawing of a typical furnace is shown in Fig. 1. Dimensions and details of the furnace construction are not critical, but a cylindrical furnace of height of 255 mm (10 in.), outside diameter of 230 mm (9 in.), and inside diameter of 130 mm (5 in.) with a removable top plug is recommended. The temperature distribution shall be such that differences in temperature greater than 2°C shall not result over

the length of the specimen beam and along the axis of the furnace from the undeflected beam plane to a point 13 mm (½ in.) below.

5.1.2 *Temperature Measuring and Indicating Instruments*—For the measurement of temperature, there shall be provided a calibrated Type R or S thermocouple. The thermocouple shall be housed in a double-bore alumina tube with its junction placed within 5 mm of the specimen near the axis of the furnace. It is recommended that the thermocouple be referenced to 0°C by means of an ice bath and its emf measured with a calibrated potentiometer having a sensitivity of ±1 µV and an accuracy of ±5 µV. Precautions shall be taken to ensure that the ice bath is maintained at 0°C throughout the test.

5.1.3 *Furnace Control*—Suitable means shall be provided for idling the furnace, controlling the heating rate, and, in the case of very hard glasses, limiting the cooling rate to not more than 5°C/min. Although commercially available programming equipment provides excellent control, a variable transformer with manual control is an inexpensive and adequate technique.

5.1.4 *Specimen Holder and Loading Rod*—A ceramic support stand and a ceramic loading rod shall be provided for

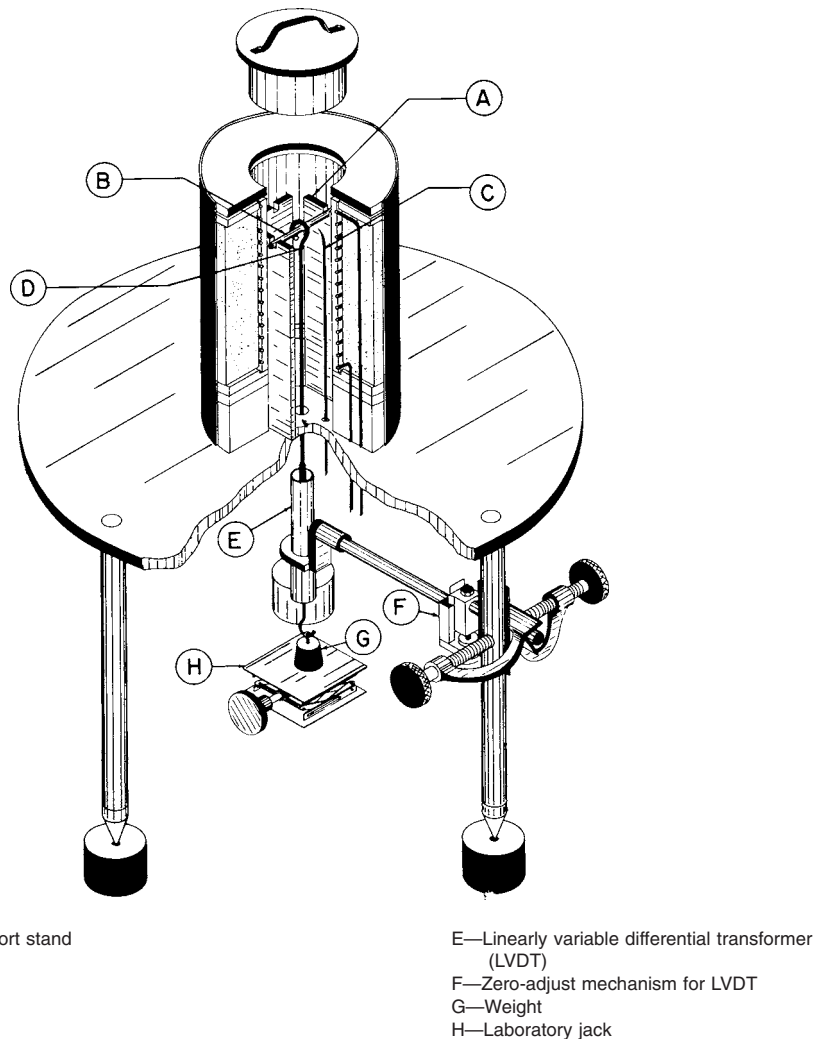

**FIG. 1 Cutaway Drawing of Beam-Bending Apparatus**

supporting the specimen and applying the load to the specimen, respectively. The thermal expansion characteristics of both stand and rod materials must be very similar so as to minimize motion of the loading rod on cooling as a result of expansion differences (see Appendix X2). A rectangular alumina muffle makes a suitable support stand (Note 1). The side walls of this muffle can be notched to define specimen position. The supporting surfaces of these notches shall be flat and lie in a plane perpendicular to the axis of the furnace. The inside edges of these supporting surfaces define the support span once the specimen beam starts to deflect. A support span of about 50 mm is recommended. A suitable loading rod can be provided by a single-crystal sapphire rod flame bent at one end in the form of a shepherds' crook.<sup>5</sup> The arrangement is shown in Fig. 1.

NOTE 1—Vitreous silica is a suitable material for both support stand and loading rod. It is not recommended for temperatures above 900°C.

5.1.5 *Extensometer for Measuring Midpoint Deflection*—The means of observing the rate of midpoint deflection of the beam should be such as to indicate reliably over a range of at least 2.5 mm. The graduated scale of the extensometer shall permit direct reading to 0.025 mm and estimates of 0.0025 mm. Its accuracy shall be such that the error of indication will not exceed  $\pm 0.005$  mm for any length change. To ensure this accuracy, the extensometer shall be precalibrated. A linearly variable differential transformer (LVDT) is suitable for this purpose but any device (optical, capacitive, or other) may be used, provided that length changes are reliably measured as specified. The arrangement with the LVDT is shown on Fig. 1. The core of the LVDT is attached to the end of the loading rod, whereas the coils are attached to the leg of the furnace platform. A screw arrangement is provided in the coil attachment assembly to move the coils vertically for zeroing purposes.

5.1.6 *Micrometer Calipers*, with an accuracy of at least 0.01 mm, for measuring specimen dimensions.

## 6. Preparation of Test Specimen

6.1 Specimens may either be flame drawn or centerless ground into cylindrical form or diamond-saw cut and mill ground into rectangular form. Nonuniformity of any dimension along the length of the specimen shall not exceed 2%. For a support span of 50 mm, the cross-section moment of inertia shall be between  $2 \times 10^{-4} \text{ cm}^4$  and  $10 \times 10^{-4} \text{ cm}^4$ .

## 7. Calibration and Measurement with Standard Glass

7.1 *Calibration*—Determine the deflection rates at the annealing point using test beams of a calibrating glass<sup>6</sup> which cover a range of cross-section moments of inertia. Determine the deflection rates by following the standard procedure described in Section 8 and in 9.1. The range of cross-section

<sup>5</sup> Flame bent sapphire hooks, available from Insaco Inc., PO Box 422, Quakertown, PA, 18951, have been found suitable for this purpose.

<sup>6</sup> Calibrating glasses known as standard reference materials (SRMs) are available from the National Institute of Standards and Technology (NIST). See Table 1 of NIST Special Publication 260, SRM Program, NIST, Gaithersburg, MD 20899. Glass SRMs are available and their certified values are listed in the back of Vol 15.02, 1999 ASTM Annual Book of Standards.

moments of inertia shall bracket the expected operating range but be limited to the maximum permissible variation as specified in Section 6. Carry out tests keeping load, span, and cooling rate constant. Make a linear calibration plot as shown in Fig. 2. Then use this calibration plot to determine the deflection rates at the annealing points of unknown glasses having similar annealing points. It is recommended that the apparatus be recalibrated periodically depending upon incidence of usage.

7.2 *Annealing Point Measurement*—Measure the deflection rate of the glass under test in accordance with the standard procedure as described in Section 8. Obtain a plot as in Fig. 3 by following the procedure described in 9.1. Select from the calibration plot in 7.1 the deflection rate of the calibrating glass having the same cross-section moment of inertia as the test glass. Using the deflection rate thus obtained, determine the corresponding temperature from the plot of the glass under measurement. This temperature is the annealing point of the glass under test.

7.3 *Strain Point Determination*—Obtain the strain point by extrapolation of the straight-line plot in 7.2. (See Fig. 3.) Divide the midpoint deflection rate at the annealing point by 31.6 to obtain the midpoint deflection rate at the strain point. From the plot in 7.2 (Fig. 3), select the temperature corresponding to this deflection rate. This temperature is the strain point of the glass under test.

## 8. Procedure

8.1 With the furnace at least 25°C (45°F) below the estimated annealing point, remove the top plug and place the specimen beam across the support stand at the notch points. Carefully engage the loading rod to the specimen and center it using long calipers. Replace the top plug.

8.2 Apply a weight to the hook on the end of the LVDT core as shown in Fig. 1. Adjust the total applied load consisting of the loading rod, LVDT core, hooks and fixtures, and weight according to the cross-section moment of inertia of the test

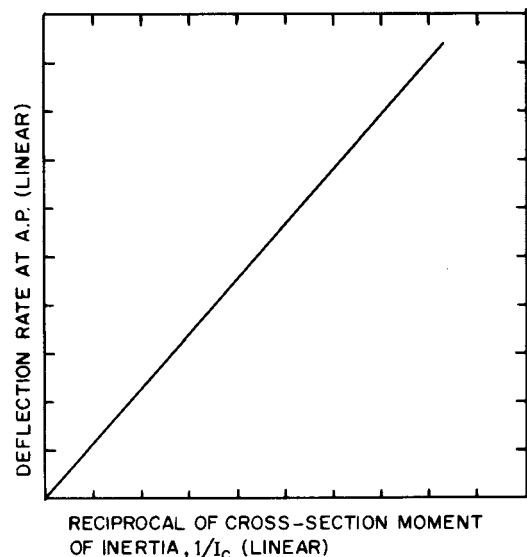

FIG. 2 Graphical Calibration Plot of Deflection Rate Versus Reciprocal of Moment of Inertia of Standard Glass Test Beams

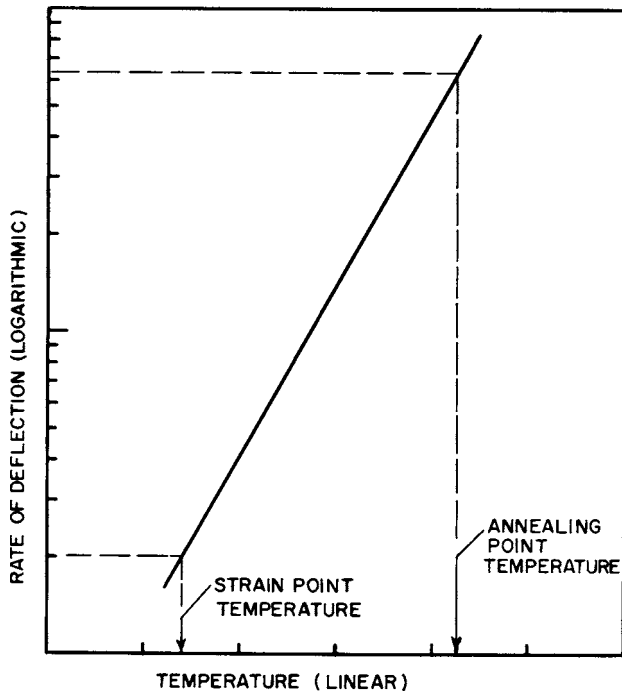

FIG. 3 Graphical Method of Analyzing Deflection Rate-Temperature Data

establish a cooling rate of  $4 \pm 1^\circ\text{C}/\text{min}$  when the specimen midpoint deflection rate in centimetres per minute reaches:

$$(4 \times 10^{-10} L^3 M)/I_c \quad (2)$$

Reset the extensometer to the lower end of its range.

NOTE 2—This deflection rate, corresponding to a viscosity of  $10^{12}$  P, guarantees erasure of previous thermal history.

8.4 Immediately after cooling has been established, take readings of both the extensometer and potentiometer alternately at 30-s intervals so that each will be read at 1-min intervals. Continue readings until the temperature is  $10^\circ\text{C}$  below the annealing point. Such a temperature will generally be reached when the extensometer indicates a deflection rate three times less than that expected at the annealing point. If the extensometer goes off range during the test, reset it to the lower end of the range by means of the vertical zeroing screw. Total beam deflections greater than 10 mm are excessive.

9. Interpretation of Results

9.1 *Plotting Data*—Take the change in extensometer readings during each 1-min interval as the rate of midpoint deflection at the temperature recorded for the middle of that minute. Plot it logarithmically against its corresponding temperature, using standard-form 3-cycle graph paper with 85-mm (3.33-in.) length cycles and linear scale 381 mm (15 in.) long with 300 divisions. The relation should be substantially linear; draw a straight line to represent the plotted points as in Fig. 3.

9.2 *Annealing and Strain Points*—Determine the midpoint viscous deflection rate of the test beam corresponding to the annealing and strain points as described in Section 7. From the graph relating deflection rate to temperature, determine the temperatures corresponding to these deflection rates. These temperatures will be the annealing and strain points.

specimen. The appropriate total load may be approximated from Fig. 4, which shows this load plotted as a function of cross-section moment of inertia.

8.3 Adjust the position of the extensometer to the lower end of its measuring range. Then start heating the furnace at a convenient rate, preferably at about  $5^\circ\text{C}/\text{min}$ . Stop heating and

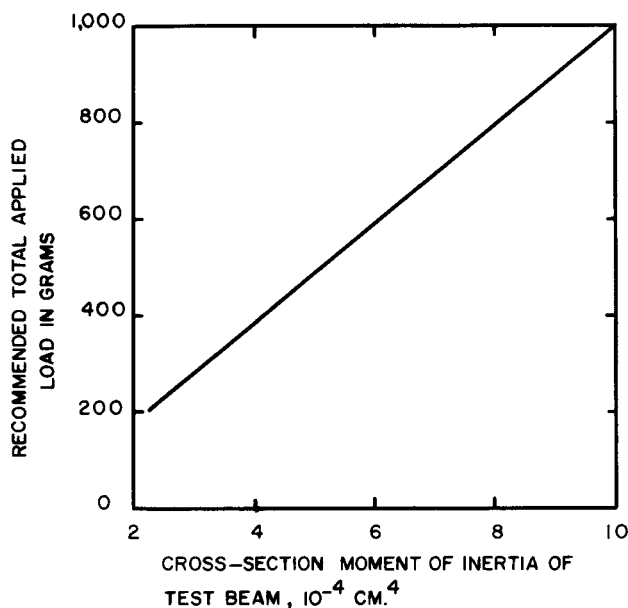

FIG. 4 Recommended Load Versus Cross-Section Moment of Inertia for Test Burns

10. Report

- 10.1 Report the following information:
  - 10.1.1 Identification of the glass tested,
  - 10.1.2 Manufacturing source and date,
  - 10.1.3 Calibration reference,
  - 10.1.4 Annealing point,
  - 10.1.5 Strain point, and
  - 10.1.6 Date of test and name of operator.

11. Precision and Bias

11.1 This procedure in general will yield annealing points to  $\pm 2^\circ\text{C}$  (standard deviation) of standard values. A rigid test of the apparatus is to calibrate with one NIST SRM and then measure other NIST SRMS based on this calibration. If the other standard glasses values are within  $2^\circ\text{C}$  of certification, excellent performance has been established. If errors arise that increase as the difference in annealing points increases, a temperature measurement or distribution problem may exist. This should be corrected. If attempts to correct such a situation are unsuccessful, an unknown glass should never be measured without calibration with a standard reference glass as close as possible in annealing point.

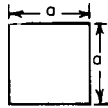
**APPENDIXES**
**(Nonmandatory Information)**
**X1. MOMENT OF INERTIA,  $I_c$ , FORMULAS FOR VARIOUS CROSS-SECTION GEOMETRIES**

**Square**

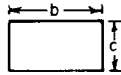
$$I_c = a^4/12$$

**Rectangular**

$$I_c = bc^3/12$$

**Circular**

$$I_c = \pi d^4/64$$

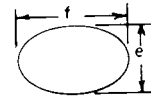
**Elliptical**

$$I_c = \pi fe^3/64$$

**X2. VERIFICATION OF SPECIMEN STAND AND LOADING ROD**

X2.1 To evaluate the effectiveness of matching the thermal expansion characteristics of materials used for both specimen stand and loading rod, the following procedure is recommended: In place of a specimen glass beam put a 0.13-in. (3.18-mm) diameter single-crystal sapphire rod on the support stand. Engage the loading rod and center it in the usual manner. Place a moderate weight at the end of the LVDT core. Replace the top plug of the furnace and heat to some temperature above the usual operating temperature range. Set the extensometer

near the middle of its range. Establish a cooling rate of  $4 \pm 1^\circ\text{C}/\text{min}$  and record extensometer readings at intervals of 1 min throughout the temperature range used for annealing point determinations. No motion should result. Any motion detected is probably due to expansion differences. Rates above 0.005 mm/min are excessive and should be corrected either by (1) correcting observed rates of deflection during actual testing by this amount or (2) selecting two materials with closer expansion match.

*ASTM International takes no position respecting the validity of any patent rights asserted in connection with any item mentioned in this standard. Users of this standard are expressly advised that determination of the validity of any such patent rights, and the risk of infringement of such rights, are entirely their own responsibility.*

*This standard is subject to revision at any time by the responsible technical committee and must be reviewed every five years and if not revised, either reapproved or withdrawn. Your comments are invited either for revision of this standard or for additional standards and should be addressed to ASTM International Headquarters. Your comments will receive careful consideration at a meeting of the responsible technical committee, which you may attend. If you feel that your comments have not received a fair hearing you should make your views known to the ASTM Committee on Standards, at the address shown below.*

*This standard is copyrighted by ASTM International, 100 Barr Harbor Drive, PO Box C700, West Conshohocken, PA 19428-2959, United States. Individual reprints (single or multiple copies) of this standard may be obtained by contacting ASTM at the above address or at 610-832-9585 (phone), 610-832-9555 (fax), or service@astm.org (e-mail); or through the ASTM website (www.astm.org).*